

SHOW NUMBER!

# RADIO

REG. U.S. PAT. OFF.

# WORLD

A GREAT ISSUE!

Sept. 15th  
1928  
15 Cents

The First and Only National Radio Weekly  
338th Consecutive Issue—Seventh Year

32 Pages  
EACH ONE  
Absorbing

## HOW TO BUILD A TELEVISION RECEIVER!

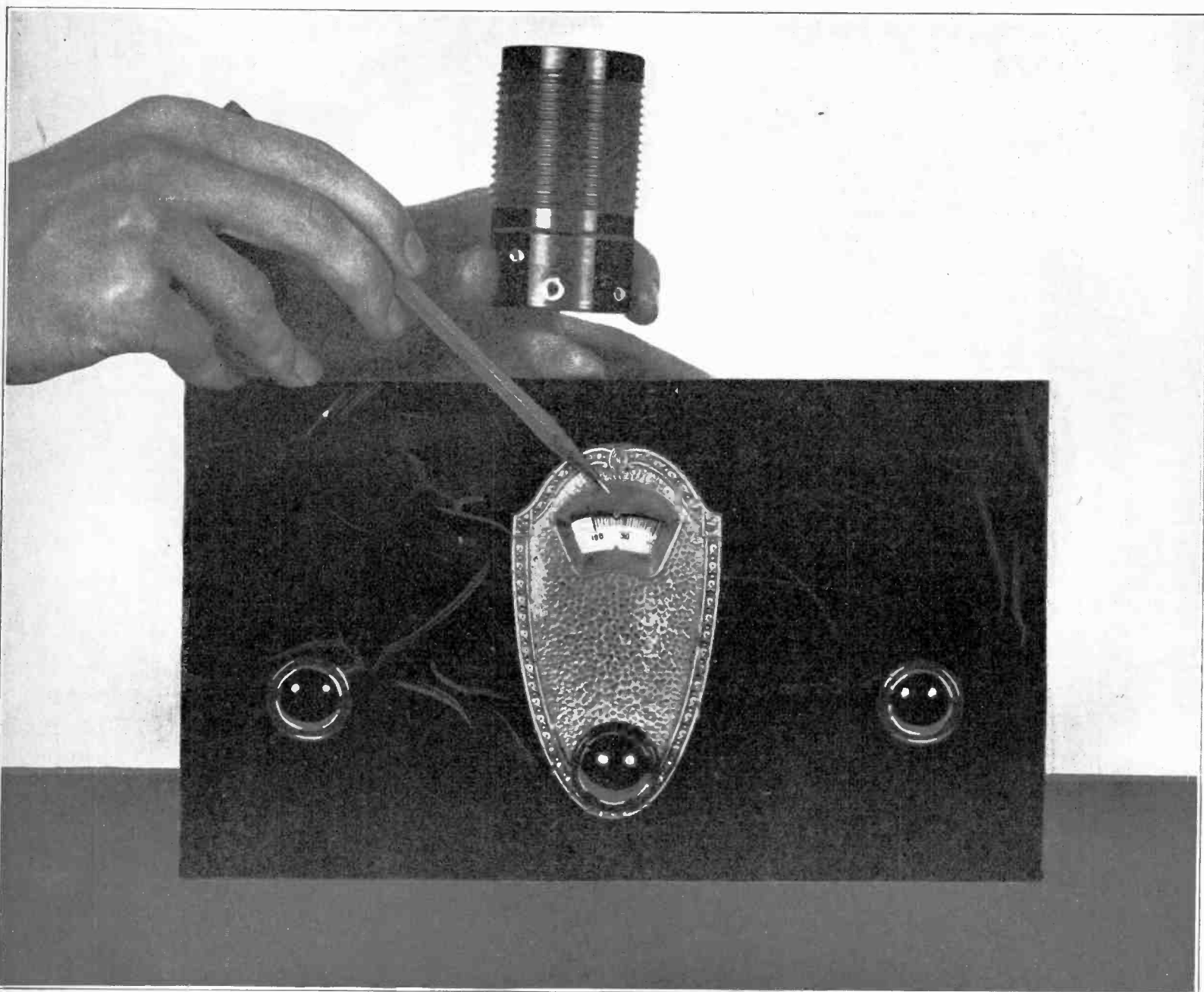

Jenkins' Televised Movies Come in Regularly, Three Nights a Week, at 93 on the dial, using this coil in the National Short Wave Circuit. See James Millen's Article on Pages 5, 6, 7, 8, 9, 10 and 11

# New Coils Produce Revolutionary Results!

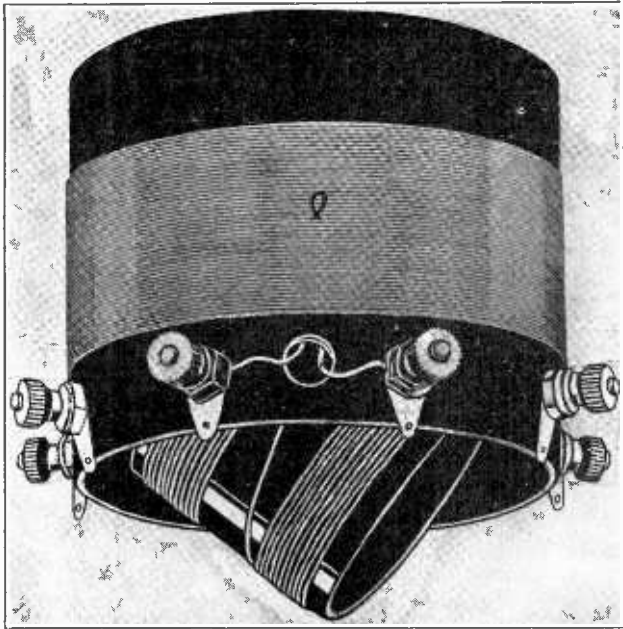

High Impedance Screen Grid Tuner, three windings. Primary center-tapped for short waves. Single hole panel mount. (Model 5HT)..... **\$3.00**

**ENORMOUS VOLTAGE GAIN!  
MORE VOLUME! MORE DX!  
THE SHORT AND LONG WAVES  
WITHOUT CHANGING COILS!**

**WORKING** out of a screen grid tube, the High Impedance Tuner develops incredible voltage.

The primary, the outside winding, is tuned by a variable condenser the user puts across it. At resonance this gives *infinite impedance!* What the screen grid tube needs is a high impedance plate load, otherwise the tube's full, amazing quantity of amplification is missed. Could there be any impedance higher than *infinite?*

The secondary has a step-up ratio of about 2-to-1, the first time a voltage increase by radio frequency coupling ever has been made available with a tuned primary. The secondary is wound on a separate form and riveted inside the primary form.

The third winding is rotatable inside the secondary form, from a front panel knob, and has a variety of uses. Bakelite forms are used exclusively.

It is inconceivable the revolutionary effect this coil has—volume so great you would never imagine it possible—greatly increased sensitivity, often 100 times greater than an ordinary TRF coil—more distant reception, much more, in fact—and—short waves may be tuned in by shorting out half of the primary, without change of coil or condenser.

Mount coil upside down for short leads. All terminals are then on bottom.

High Impedance Screen Grid Tuner Primary Center-tapped for short waves. Single hole panel mount (for .005 mfd.). Model 5HT ..... **\$3.00**  
For .00035 mfd. Model 3HT..... **\$3.25**

## Wonders of Screen Grid Tubes Fully Capitalized for First Time

### ANTENNA COIL

Like the High Impedance Tuner, the Screen Grid Antenna Coil is specially designed for input to a screen grid tube. Its inductance is so arranged that the dial readings of the antenna circuit will be like those of the tuned circuit in which the High Impedance Tuner is used.

The antenna coupling is conductive, giving the maximum signal strength consistent with selectivity—a degree of volume that is so enormous as to astound you! Using these two coils, the volume is so great that only one stage of audio works a loud speaker superbly—thrillingly!

For short wave reception all except 14 turns of this single, continuously-wound coil are shorted out, and short-wave tuning confined to the succeeding stage or stages.

The Screen Grid Antenna Coil is matched to the High Impedance Tuner, by having dissimilar turns that equalize the tuning. Dial readings track nicely because the Screen Grid Antenna Coil's individual inductance is made to atone for the effect mutual inductance has on the High Impedance Tuner's primary.

Screen Grid Antenna Coil. One tap for short waves. For .0005 mfd. (Model 2A) **\$1.75**  
For .00035 mfd. use (Model 3A)..... **\$2.00**

### REPLACEMENT COIL

A great many persons now possess good radio receivers and do not desire to part with them, but would like to gain the benefit of the wonderful new screen grid tubes that, with proper coils, increase volume and sensitivity enormously, and without reducing selectivity.

Moreover, they do not want to tear down existing receivers and virtually rebuild them. No need to do so. The Screen Grid Replacement Coil, for either .0005 mfd. or .00035 mfd. tuning, occupies a space only 2 1/2 x 2 1/2 inches, so can be put in almost any receiver from which the old coil has been removed.

The replacement coil has an untuned primary of high impedance—generous number of turns—while the secondary is tuned. Thus it conforms to requirements of the usual tuned radio frequency receivers. Custom Set Builders, Service Men and Home Experimenters will welcome this opportunity to redeem "the old set," make it pep up and step out—cure that loss of the old kick—capitalize the great advantages of radio's outstanding tube! In replacement work one of these coils should be used as the antenna coil.

Screen Grid Replacement Coil for .0005 mfd. Secondary center-tapped for short waves. (Model 2R5) ..... **\$1.50**

Screen Grid Replacement Coil for .00035 mfd. Secondary center-tapped for short waves. (Model 2R3) ..... **\$1.75**

### OTHER SCREEN GRID COILS

For circuits using screen grid tubes, with single tuning control, four models of coils are manufactured with rotors that serve as trimmers, so that no midget trimming condenser is needed.

These single control coils are:

Model 2SC5. Conductively coupled antenna coil, for input to a screen grid tube, with two turns taken from the stator and wound on the rotor. Thus the variations in tuning, due to the antenna's capacity effect on the tuned circuit, are compensated for by turning the panel knob. For .0005 mfd. tuning. Usual tap for short waves. (Model 2SC5) ..... **\$2.75**

Model 2SC3, same as above, except that inductance is for .00035 mfd. tuning. Usual tap for short waves. (Model 2SC3)..... **\$3.00**

Model 2RSC5 is a 'replacement coil for single control sets, corresponding to 2R5, but having the trimmer coil on a rotatable form, so that any interstage coupling out of a screen grid tube may be accomplished efficiently. Usual tap for short waves. (Model 2RSC5) ..... **\$2.75**

Model 2RSC3, same as above, except this is for .00035 mfd. tuning. Usual tap for short waves. (Model 2RSC3)..... **\$3.00**

### Coils for Other Than Screen Grid Tubes

For all circuits other than screen grid circuits the STANDARD group of coils is manufactured, as distinguished from SCREEN GRID Coils. The STANDARD coils are for 201A, 240, 199, 226AC, 227AC and all other non-screen grid tubes.

All the coils, both STANDARD and SCREEN GRID, have 2 1/2 inch diameter, the smallest diameter consistent with high efficiency!

All are sturdily made and are carefully designed and constructed with the idea of having them last TEN YEARS. That includes coils with rotatable forms, for they are no less rugged than the others—another exceptional virtue.

All coils have a short-wave tap, but this need not be used, if not desired.

### STANDARD COILS

3-circuit tuner, for .0005 mfd. Secondary center-tapped for short waves. (Model T5) ..... **\$2.25**

3-circuit tuner for .00035 mfd. Secondary center-tapped for short waves. (Model T3) ..... **\$2.50**

TRF coil. Interstage coupler and also used as antenna coil. For .0005 mfd. Secondary center-tapped for short waves. (Model RF5) ..... **\$1.00**

TRF coil. Same as above, except it is for .00035. Secondary center-tapped for short waves. (Model RF3) ..... **\$1.25**

[Note: This advertisement contains our complete line of coils. Inquiries invited from the trade, custom set builders, etc.]

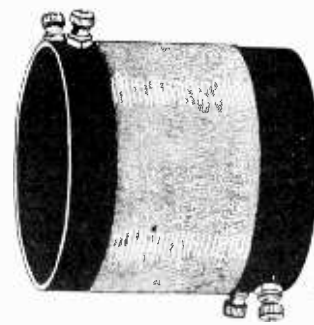

Screen Grid Antenna Coil, for Input to any Screen Grid RF Amplifier. Tapped once for short waves. (Model 2A) ..... **\$1.75**

### SCREEN GRID COIL COMPANY

143 WEST 45th STREET  
NEW YORK CITY

Just East of Broadway

Please mail me at once your following coils, for which I will pay post-man the advertised prices plus a few cents extra for postage.

Screen Grid Coil Co., 143 W. 45th St., N. Y. City. [Specify Quantity in the Squares]

Model.....  Model.....  Model.....  Model.....  Model.....  Model.....

Name.....  
Address.....  
City.....  
State.....

SEND NO..... (RW)

# YOU MUST GET THIS BOOK!



**DRAKE'S RADIO CYCLOPEDIA**  
(New Edition)

has been developed to answer the questions of service men, custom set builders and home constructors, of experimenters, students, salesmen and operators of receiving equipment and to allow all these to have instant access to the information they want. The author, Harold P. Manly, has collected and translated into plain English the material formerly obtainable only from dozens of scattered sources.

Each rule, fact, method, plan, layout and diagram is instantly picked out and separated from everything else by placing all subjects in alphabetical order with cross references for every imaginable name under which the information might be classed.

BOOK IS 2 1/2" THICK, WEIGHS 3 3/4 LBS., 1,025 ILLUSTRATIONS.

This alphabetical arrangement lets the experienced worker refer directly to the one thing in which he is interested at the moment without hunting through non-essentials. The needs of the beginner are cared for.

The important articles deal primarily with receivers and reception. They do not stop with the electrical end, but go also into the mechanics of construction. Every new thing in radio is covered in detail.

- 1,680 Alphabetical Headings from A-battery to Zero Beat
- 1025 Illustrations, Diagrams, Layouts and Graphs
- 920 Pages, Each 6 by 9 inches
- 240 Combinations for Receiver Layouts

### OF THE PRINCIPAL ARTICLES

159 concern service men, 129 help the set builder, 162 help the experimenter, 155 interest the student, 75 assist in sales work, 73 interest set owners.

Radio World: "The most suitable volume for those who want the facts stripped as far as possible of intricacies. Useful addition to any library."

Radio Broadcast: "The reviewer does not believe that a more satisfactory addition to the experimenter's library in any one volume can be made."

QST: "The information is so put as to be of most immediate use to the constructor and repair man, and, remarkably enough, includes apparatus of most recent origin."

Radio: "Seldom is any subject so comprehensively and practically explained."

**GUARANTY RADIO GOODS CO.**  
145 W. 45th St., New York, N. Y. (Just E. of B'way)  
Gentlemen: Please mail me at once the new (second) edition of "Drake's Radio Cyclopeda," by Harold P. Manly, just published, with all the latest technical information in it. I will pay the postman \$8.00 plus a few cents extra for postage. If I am not delighted, I may return the book in three days and you will promptly refund my purchase money.

Name .....

Address .....

City ..... State .....

**5-DAY MONEY-BACK GUARANTY!**

# SUBSCRIBERS!

## Look at the Expiration Date on Your Wrapper

Please look at the subscription date stamped on your last wrapper, and if that date indicates that your subscription is about to expire, please send remittance to cover your renewal.

In this way you will get your copies without interruption and keep your file complete.

Subscription Dept., **RADIO WORLD**, 145 West 45th Street, New York City.

STOP! AT BOOTH FF-2—EXPOSITION HALL

# Practical Television

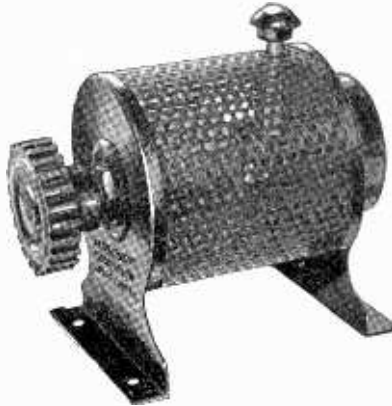

Given a good signal and kino-lamp, satisfactory television comes down to the correct scanning disk driven at proper speed and in perfect step.

The TELEVISION CLAROSTAT has been designed to serve both functions. Provides stepless speed control for universal or condenser type motor up to 1/4th horsepower. Push-button serves for momentary acceleration, in getting into perfect step. Sturdy, ventilated iron casing with mounting feet. 80-watt rating. Convenient. Easily operated. Ideal for television—but also excellent for many other applications.

**Write** for descriptive literature on Television Clarostat and other Clarostats for every radio purpose. Better still, send 25 cents in stamps or coin for "The Gateway to Better Radio"—88 diagrams and over 20,000 words of practical data.

**CLAROSTAT MFG. CO., Inc.**

Specialists in Variable Resistors

285-7 North Sixth St. :: Brooklyn, N. Y.

**CLAROSTAT**  
REG. U. S. PAT. OFF.

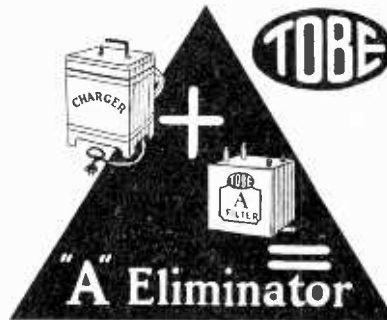

ANY standard charger, such as Tungar, Rectagon, bulb or electrolytic, etc., can be converted in less than a minute to a four or six volt A eliminator by using a **TOBE A FILTER**.

Tobe A filter is a development consisting of 8000

Mfd. of dry condenser and two chokes mounted in a container.

This combination, a charger and a Tobe A filter, does away with your messy A battery forever.

*Convert* charger into "A" Eliminator in less than a minute

Tobe A filter list price \$18.00

If unable to obtain this unit at your dealers' write direct.

Also ask for latest complete catalog.

**TOBE DEUTSCHMANN CO.**

NEW YORK

CANTON, MASS.

CHICAGO

HAVE YOU MISSED ANY COPIES OF RADIO WORLD WHILE ON YOUR VACATION?

If so we can furnish you with any numbers of Radio World for the entire Spring and Summer of 1928. Any one issue, 15c, any seven issues, \$1.00. Find out what copies you are short of and send your order. Copies will be sent to, postpaid, immediately upon receipt of price.

Radio World, 145 W. 45th St., N. Y. C.

# TELEVISION IS HERE



Television is now an accomplished fact.

Experimenters will welcome the Raytheon Kino-Lamp, the first television tube developed commercially to work with any system.

Uniform glow over the entire plate, without the use of mirrors or ground glass, gives it perfect reproduction qualities.

Kino-Lamp is the latest achievement of the Raytheon Laboratories which have made so many original contributions to radio science. Write for information.

## Raytheon Foto-Cell

Available in both hard vacuum and gas-filled extra sensitive types—each in two sizes.

Write us for special specifications.  
RAYTHEON MFG. COMPANY  
CAMBRIDGE, MASS.



## BLUEPRINT

FOR

## Bernard's Economy 3

Price \$1.00

PHILIP COHEN

236 VARET STREET  
BROOKLYN, N. Y.



## 11,000 Miles on Wasp Set

Are you getting world-wide reception? You can with a WASP short wave set, 17 to 500 meters. Complete construction kit for 3-tube WASP, with 5 coils, Micarta panels, etc., blueprints, and 48-page instruction giving 700 S. W. station calls, postpaid in U. S. A. or Canada ..... \$16.85  
Set of 5 plug-in coils only, postpaid..... \$5.75  
Panel patterns only, postpaid..... \$1.00

**SPEED, Inc., FASTEST MAIL SERVICE**

103-D BROADWAY  
BROOKLYN, N. Y.

**The Ounce of Prevention**

AMPERITE automatically prevents "A" current fluctuations, lengthens tube life, improves set operation. Entirely unlike fixed resistors. A type for every tube—battery or A.C.

Radiall Company  
50 FRANKLIN ST., NEW YORK

FREE New "Amperite Blue Book" gives latest construction data. Write Dept. R.W.18

# AMPERITE

REG. U.S. PAT. OFF.

The "SELF-ADJUSTING" Rheostat

# LYNCH

## Amplifier Kit for Quality Television Reception

This 3 stage resistance-coupled amplifier kit is available at your dealer for quality television reception. With this precision built apparatus you can easily and cheaply assemble an efficient television amplifier. \$9.00 complete.

Send for free book.

ARTHUR H. LYNCH, INC.  
1775 Broadway New York City

Complete Kit of Parts as Specified by H. B. Herman for 4-Tube

## SCREEN GRID DIAMOND \$39.50

BLUEPRINT FREE WITH EACH KIT!  
Kit consists of Hammarlund HR 23 coils, Karas tuning condensers and audio transformers, four Amperites, Clarostat, Yaxley switch and pilot bracket with lamp, aluminum subpanel with sockets on, drilled front panel, Lynch leak, Aerovox fixed condensers, Mar-co dials, Pee-wee clip, Vac-Shield, binding posts.

Custom Set Builders Supply Co.  
57 Dey Street, N. Y. City

ARTISTS and Art Students are printing 250 signs or pictures an hour without machinery. Sample and particulars 10c. Staco, 1014 Mulberry, Springfield, Ohio.

FOR SALE: Sentinel Dry A-B-C power unit with tubes \$44.50. 8 foot orthophonic horn size 24 1/2 x 18 x 15 inches, with Temple unit \$8.00. Fritts super cabinet, panel size 7" x 24" \$12.00. Multi-valve receiver \$5.00. Aerial kit \$.98. SM 222 output trans. \$3.00. Utah upright type piano speaker \$4.00. Everything guaranteed new. Charles Frick, 311 N. Cherry St., Van Wert, Ohio.

# ELIMINATE BATTERIES!

NO Change in Set Wiring  
NO Change in Tubes

**"B"** Eliminator, Using Raytheon Tube, Replaces "B" Batteries and Gives Great Satisfaction.



No. 816—"B" Eliminator for 50 to 60 cycle, 105 to 125-volt AC house current. Max. voltage, 180. with one variable detector and one variable intermediate voltage. Weight 16 lbs. Size, 6 x 6 1/2 x 11 1/2". Quiet, economical. Requires no attention. Sold only with Raytheon tube. Price, including Raytheon BH125 mll. tube and built in connector cord and plug. **\$16**

Famous Raytheon Tube With Each "B" Eliminator

**"A"** Eliminator, Using Dry Plate Rectification, Current Well Filtered; Replaces "A" Battery.



No. A22—"A" Eliminator. Supplies up to 2 1/2 amperes at 6 volts. Variable resistance permits adjustment to number of tubes in set. Supplies A current and voltage to sets using from 4 to 10 quarter ampere tubes, or equivalent current drawn by any other combinations. Tip jacks for voltmeter readings receptacle for "B" eliminator plug. Pendant switch controls everything. Set switch needn't be touched. Device requires no attention. Uses no tube. Size: 10 1/2" high, 6 1/2" wide, 11 1/2" long. Shipping weight, 27 lbs. **\$22**

CUSTOM SET BUILDERS SUPPLY CO.  
57 Dey St., N. Y. City  
Please ship at once—

- One 180-volt maximum "B" eliminator, with variable detector and variable intermediate voltage (three different voltages in all); equipped with one Raytheon BH tube, 125 milliamperes rating. I will pay \$16. Plus a little extra for freight, on receipt of goods, which are to be on approval for ten days (money back, if desired after 10-day trial).
- One "A" eliminator, 2 1/2-ampere maximum at 6 volts, using dry plate rectification, large choke and large capacity condenser. AC switch, receptacle for any "B" eliminator plug, variable resistor, all built in for which I will pay \$22, plus a little extra for freight.
- Both the "B" eliminator and the "A" eliminator, at total of \$36, on same approval basis.

Note: If fast express shipment is preferred, rather than slower freight, put a cross here

Name.....  
Address.....  
City..... State.....

**ALL SHIPMENTS MADE ON APPROVAL FOR TEN DAYS**  
All prices quoted are NET!

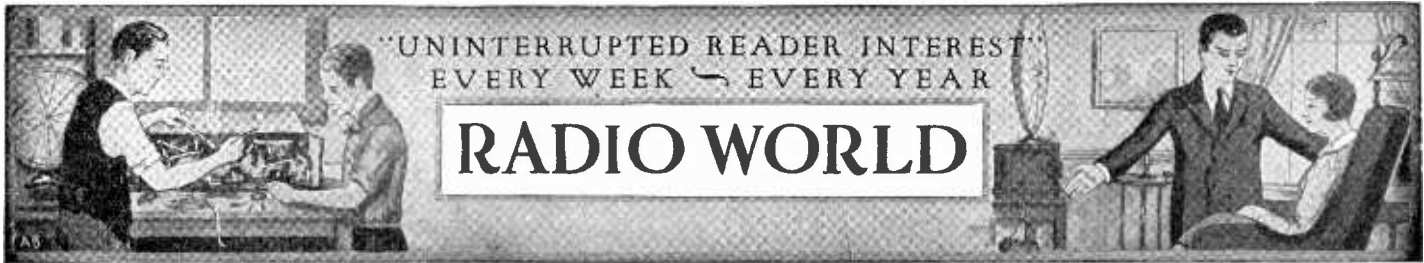

SEPTEMBER 15, 1928  
 Vol. XIII, No. 26. Whole No. 338  
 15c Per Copy, \$6 Per Year  
 [Entered as second-class matter, March  
 1922, at the post office at New York,  
 N. Y., under Act of March, 1879.]

Technical Accuracy Second to None

A Weekly Paper published by Hennessy  
 Radio Publications Corporation, from  
 Publication Office, 145 West 45th Street,  
 New York, N. Y.  
 (Just East of Broadway)  
 Phone: BRyant 0558 and 0559

# HOW TO BUILD AT \$50 AND UP A Television Receiver That Works!

James Millen Describes for the First Time Construction, Operation and Trouble-Shooting of the Circuit with Which He Broke the World's Record — Constant Clear Reception, Even Through Violent Thunderstorms — Advises All to Get Started At Once—Thrills Are Plentiful, Even Though Pictures Lack Variety

By James Millen

Holder of the World's Record for Long-Distance Reception of Televised Movies

TELEVISION is now in the state where the average experimenter can get results. It is no longer just an interesting laboratory experiment for the engineers and scientists with all the necessary facilities for transmitting as well as receiving their own signals on a wire circuit from one corner of the room to another.

With some half dozen stations putting both television and radio movie signals on the air on regular schedule, anyone with even a limited amount of special, but not necessarily expensive, apparatus added to either a standard shortwave or broadcast receiver—depending upon the stations to be received—can get results.

True, the pictures themselves are very far from the perfection—not good enough to provide entertainment, once the novelty has worn off, to the person solely interested in what he sees rather than in the experimental work in connection with pioneering in a new science. But the experimenter will find many hours of extremely fascinating work if he goes in for television at this time, in addition to the “thrills” of tuning in the image of a small girl skipping a rope or bouncing a ball some 500 miles away.

#### Plenty Now, More on Way

At this time the radio movies signals from the Jenkins Station 3XK may be picked up almost any place in the Eastern part of the United States. In New York City and adjacent suburbs WRNY's signals are receivable, using the same disc. Chicago has its own television station in WCFL, and Boston has WLEX. Then there is WGY on both broadcast and short waves.

While WGY cannot be received well in either New York or Boston, its shortwave

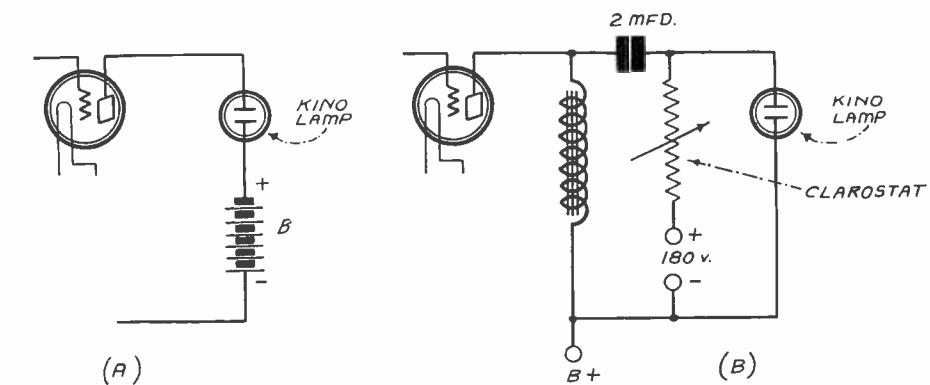

FIG. 1

“GET STARTED IN TELEVISION” IS THE ADVICE OF JAMES MILLEN, WHO TELLS IN THE ACCOMPANYING ARTICLE JUST HOW TO GO ABOUT IT. YOU CAN USE YOUR PRESENT BROADCAST RECEIVER, WITH A KINO LAMP, MOTOR AND SCANNING DISC. TWO GENERAL METHODS OF CONNECTING THE KINO LAMP ARE ILLUSTRATED. IN “A” A COMMON POTENTIAL SOURCE IS USED. IN “B” A SEPARATE SOURCE IS EMPLOYED.

signals are reported with excellent volume at times on the Pacific Coast.

Experimenters on the Pacific Coast will also be supplied soon with local television signals from several California stations now under construction.

It will be seen, therefore, that there are very few places in the whole country, even at this very early stage of television development, where it is not possible to receive

useable signals from some one of the pioneer image broadcasters.

It is surprising how weak, and to the ear, how much buried in noise, a television signal may be, yet still produce a recognizable image.

When the first receiving equipment was set up in my laboratory at Malden, Mass., for receiving the long distance radio movie

(Continued on next page)

# Follow Millen to High

## 5 "First Presentations" In Theatre of Radio

**T**HEATRES in great centers of population that can put on "first presentations" are theatres of first rank. They do not buy the honor. They earn it.

RADIO WORLD is the theatre of technical radio, with the United States and Canada as the audience.

First presentations are earned by RADIO WORLD because it is an expertly written and edited weekly, eager to render service to readers and advertisers, and publishing only the very best in text and in advertising. The spirit is one of wholesomeness, like a mother's devotion to her loved ones.

With this Show Number we present examples of the high order of our product and proof anew of unstinting service to our readers. There are five featured offerings:

James Millen, holder of the world's record for long-distance reception of televised movies, contributes the first presentation of a television receiver of demonstrated, repeated long-distance reception. Three nights a week at Malden, Mass., he tunes in C. Francis Jenkins' televised movies, sent from Washington, D. C.—a distance of 500 miles. Two weeks ago (September 1st) in these columns Mr. Millen told in great detail how he tuned in television. Last week (September 8th) he described the shortwave receiver alone. This week he gives the full constructional details on "How to Build a Televisor That Works!" What a thrill in that!

J. E. Anderson, technical editor, shows for the first time anywhere his push-pull resistance-coupled amplifier, in two forms, with difficulties so long associated with such a circuit safely removed. Mr. Anderson is one of America's foremost authors of technical radio articles. He is a former instructor of physics at the University of Wisconsin, a former Western Electric engineer, and the first man in the world to give the full analysis of oscillation in audio amplifiers ("Proceedings" of the Institute of Radio Engineers, March, 1927). See Mr. Anderson's article on pages 18 and 19.

Another "first presentation" is that of a six-tube intermediate frequency circuit for reception of 17 to 600 meters with plug-in coils. This is the first time the frequency changing system has been applied to an inexpensive all-wave set, besides being one of the few all-wave circuits ever offered. The design work was done by Herman Bernard, whose circuits for the last few months have included only one stage of audio, for reasons he previously sketched, but which he sets forth in detail in this issue. The six-tube circuit is discussed on pages 12 and 13.

Another of Mr. Bernard's circuits is The Economy Three, using only three tubes to work a speaker with one stage of audio, and developing high amplification. The circuit is familiar to RADIO WORLD readers, but this week (on pages 14 and 15) are shown new and fascinating developments: tuning range extension and maximum signal strength pick-up.

On pages 20 and 21 is an article by John F. Rider, showing the first circuit to employ the new Truvolt Divider, for voltage security and versatility in a B supply, and containing filter capacities totaling 110 mfd. The enormous capacity is made possible by the use of Mershon condensers.

Those five technical articles comprise this week's list of features.

And every article is a "first presentation"!

They are by no means the only articles in this issue, either.

**Extreme Accuracy of High - Quality Transformer**  
**—Pictures Received Upside**  
**--Intimate Narrative of How**  
**—Induction Motor Used with**  
**—Noisy Signals Bring in Good**

ments from Washington could not be understood, easily recognizable images were picked up.

To simplify the description of the apparatus used in this pioneer long-distance television reception the receiver will be divided into the following parts:

- The Tuner.
- The Audio Amplifier.
- The Kino Lamp.
- The Scanning Device.

### The Tuner

The Jenkins signals are now transmitted on a wavelength of 46.7 meters between 8 and 9 p.m., E.S.T. (9 and 10 p.m. Daylight Saving Time) on Monday, Wednesday and Friday. While these signals may be picked up with almost any type of shortwave receiver or shortwave adapter attached to a broadcast receiver, it has been found that for really satisfactory picture work a receiver employing a stage of untuned RF using the 222 screen grid tube ahead of a regenerative detector is superior.

The reason is twofold.

In the first place, the RF amplification permits the tuning in of the signal without using full regeneration which, if employed, would result in the elimination of some of the higher audio frequency components of the picture signal and thus spoil the sharpness of outline and the amount of detail in the image.

In the second place, anyone who has operated a shortwave regenerative detector circuit with the antenna directly coupled either through a small primary or an antenna series condenser knows only too well what a very small amount of vibration or swinging of the antenna lead can do to the signal. By having an untuned antenna circuit such difficulty is completely eliminated and the vibration from the scanning disc motor as well as the jars resulting from people moving about the room will have no detrimental effect upon the steadiness and quality of the signal.

The National shortwave circuit as de-

(Continued from preceding page) transmission of 3XK from Washington, D. C., it was felt that there would be little chance of success, due to the very weak signals and strong Summer static.

Even so, the pictures were received regu-

larly all Summer without missing a single schedule, although local thunderstorms occurred during several of the evenings on which tests were scheduled. In fact, at times, when the signals were so weak and the static so bad that the voice announce-

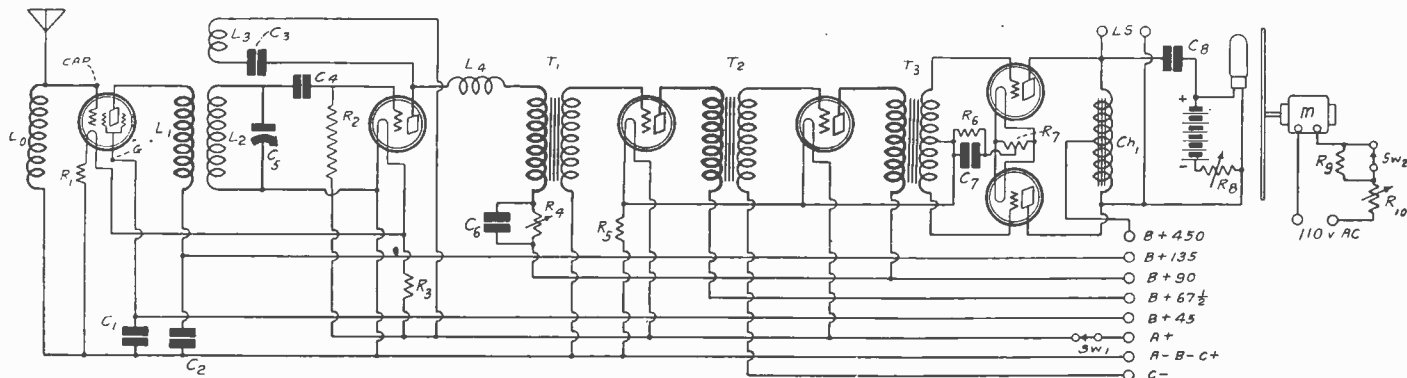

FIG. 2

THE COMPLETE CIRCUIT OF JAMES MILLEN'S SHORT-WAVE RECEIVER, AUDIO AMPLIFIER AND TELEVISION ADAPTER, WHICH HE USED WHEN HE BROKE THE WORLD'S RECORD.

# Success in Television!

**Scanning Disc Is Essential — Audio Stages Recommended Down or With Sides Reversed These Faults Were Corrected Resistors as Speed Regulators Pictures Nevertheless**

scribed in detail in last week's issue of RADIO WORLD (September 8th) meets these requirements in a most excellent manner and is therefore highly recommended for television reception. It is the circuit I used in my successful reception of 3XK.

In addition this receiver has been designed without any audio amplifier, so that the high-quality type required for television work may be readily added without making any changes in the receiver kit.

Four plug-in RF transformers are supplied with the National kit to cover the following wave bands:

- Coil A: 15-25 meters.
- Coil B: 24-40 meters.
- Coil C: 37-65 meters.
- Coil D: 60-115 meters.

Coil C is the one to use in receiving 3XK, which will tune in at or near 93 on the dial. (See front cover illustration). This dial setting will vary slightly with different kits, but will seldom be more than a few points

### LIST OF PARTS

For Complete Short-wave Television Receiver

- L1, L2, L3—One set of four National short-wave plug-in coils.
- C1, C2—Two .5 mfd. Aerovox condensers, 200 volt test.
- C3—One .001 mfd. Aerovox condenser.
- C4—One .00025 mfd. Aerovox condenser.
- C5—One .000125 mfd. National tuning condenser.
- C6—One 1 mfd. Aerovox condenser, 200 volt test.
- C7—One 2 mfd. condenser, 200 volt test.
- C8—One 4 mfd. condenser, 400 volt test.
- R1—One Lynch Equalizer, Type 15.
- R2—One Lynch 6 megohm metallized resistor.
- R3—One Lynch Equalizer, Type 2.
- R4—One Electrad 0-500,000-ohm resistor.
- R5—One Lynch Equalizer, Type 2.
- R6—One 750-ohm resistor.
- R7—One center tapped 50-ohm resistor.
- R8—One Television Clarostat.
- R9—One Lynch 10-ohm resistor.
- R10—One 0-75-ohm rheostat.
- Sw—One Yaxley filament switch.
- L0—One National choke, Type 10.
- L4—One National radio frequency choke, Type 1.
- Two National audio transformers.
- One National push-pull input transformer.
- One National push-pull output choke.
- One Raytheon Kino lamp.
- One National 24-inch diameter 48-hole scanning disc.
- One Baldor 1/8 horse-power induction AC motor.
- Seven standard sockets.
- Three 112A tubes.
- Two 210 tubes.
- One National dial with pilot light.
- Sixteen binding posts.

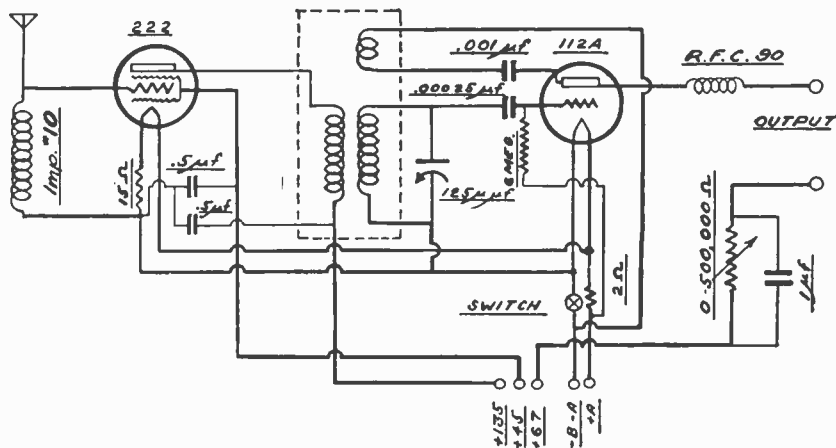
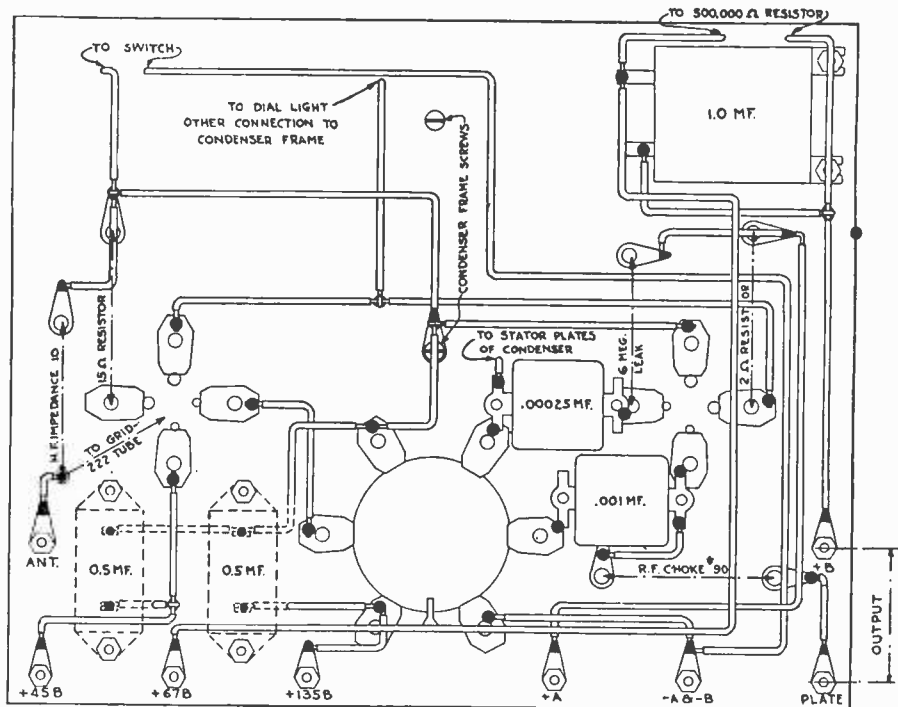

FIGS. 3 AND 4

THE SHORT-WAVE RECEIVER ALONE, SHOWN IN PICTURE DIAGRAM FORM AS WELL AS SCHEMATICALLY.

away. WLEX will be found at about 150 on the dial when using the C transformer and in some cases may be better received by using coil D with the condenser dial set somewhere near 10.

But more about the tuning later.

The next step is to get a suitable audio amplifier assembled to work with the short-wave receiver.

### The Audio Amplifier

While almost any kind of an audio amplifier may be used, the quality, sharpness and detail of the received images depend to a very great extent on the over-all amplifier frequency characteristic.

Thus at the transmitting end it is now universal practice to employ a multi-stage resistance coupled amplifier or very high class transformer channel between the photocells and the transmitter proper. Likewise, for the best results, a resistance coupled amplifier is recommended at the receiving end as being best from a theoretical point of view, if B batteries are used. Under present conditions; however, where there are no stations transmitting television signals containing frequencies in excess of 5,000

cycles, there is nothing to be gained by using a resistance coupled amplifier in place of a good transformer coupled chain. In fact, there are several reasons why the transformer coupled amplifier, providing it employs high grade transformers—is preferable to a resistance coupled amplifier, so long as the transmitting stations are not sending signals containing frequencies over 5,000 cycles, particularly not extending up as high as 30,000 or more, which some authorities claim as being essential for truly excellent image quality.

Perhaps one of the most important of these advantages in favor of transformer coupling is the few stages required where the signal strength is quite weak. As a result, the amplifier will be found much more stable and quieter than had it been necessary to use a multi-stage resistance coupled outfit. Then still another advantage in favor of the transformer coupled amplifier is the reduction in static and other noises resulting from the sharp 5,000 cycles cut-off characteristic of the modern high-quality audio transformer.

Poor or even medium-grade transformers  
(Continued on next page)

# Negative Image Turns Pos



FIG. 5  
REAR VIEW OF THE SHORT-WAVE RECEIVER ALONE. TO THIS WAS  
ADDED THE AUDIO CHANNEL TO FEED THE KINO LAMP.

(Continued from preceding page)  
should not be used, however, unless the financial saving is of extreme importance. While a good transformer coupled amplifier will give as good or better results with existing signals as a resistance coupled amplifier, a transformer coupled amplifier employing poor transformers will give an image with fuzzy rather than clear-cut edges and with a noticeable lack of detail.

The transformers I used are the new National Veritones, which have an unusually flat frequency characteristic curve from 30 to 5,000 cycles. By arranging the transformers and sockets on a long narrow board very little wiring is required, and even that may be run underneath so as to produce a neat appearance.

#### Sockets Important

Spring suspended sockets should preferably be used in building up the amplifier in order to reduce the possibilities of microphonic tube noises when motor and disc are located close by.

Noise does not present the same limitations in a television receiver that it does in a broadcast receiver. Any noise is bothersome if you must listen to it, but in a picture it is represented by black spots and streaks that appear in a continually shifting position, unless the noise is periodic.

Poor coupling resistors and vibration are the two most common sources of noise in the resistance coupled amplifier. If in an early stage of an amplifier a plate coupling resistor is defective it will introduce noise that is later amplified. A pair of headphones connected to the output terminal will reveal this noise. Of course, some noise is to be expected from a high-gain amplifier, but one can easily judge the amount of noise that is permissible by tapping the tubes and

comparing the microphonic noise with the amplifier noise.

#### Quiet Amplifier

As a rule, in three stages of amplification, the amplifier noise will not be appreciable. Unless there is a defective resistor in one of the plate circuits the amplifier will be quiet.

Vibration from the receiving disc or its motor transmitted to the amplifier or especially to the detector tube will introduce a periodic noise that will put a black streak across the field of the picture. Any periodic interference such as a 60-cycle hum that may get into the signal also will cause streaks across the picture, but these will not remain stationary. They will move upward or downward across the field of the picture.

#### The Output Circuit

In the television receiver the neon lamp (Kino lamp) and scanning disc take the place of the loudspeaker in the radio set. The loudspeaker, however, should not be entirely omitted, as it will not only prove useful in tuning in the television signals but also in listening to the announcements.

The output circuit is so arranged that the Kino lamp is always illuminated, and when a signal is received the brilliancy of illumination varies in accordance with the signal.

The construction of the tube is quite simple. There are two flat metal plates placed parallel and very close together. They are one and one-half inches square, presenting an area of two and one-quarter square inches. They are mounted so that both plates present a clear surface. In this way either plate can be used as the anode. These plates are in a space containing neon gas.

When the current through the tube is

## Expert Advice

### On Television

Most readers will appreciate the fullest possible assistance in the construction of a television or the adaptation of an existing receiver to television purposes.

James Millen, holder of the world's record for repeated reception of televised movies, and author of "How to Build a Television Receiver That Works," offers to assist readers. He is fully capable of answering questions on any and all phases of this most recent and most fascinating art. He has undertaken this large task as an added contribution on his part to the development of the radio. Address him: James Millen, c/o RADIO WORLD, 145 West 45th Street, New York City. Blueprint inquiries also should be sent to him.

changed due to a change in impressed voltage, the amount of light emitted is changed. This fact is utilized to reproduce the picture.

There are two general methods of connecting the Kino lamp in the output of the audio amplifier. In the method shown at A in Fig. 1 the lamp is merely connected in the plate circuit of the power tube and then the B voltage on the power tube increased by 160 volts which corresponds to the DC drop across the Kino lamp. The C bias on the power tube should then be readjusted for best results after the signal has been tuned in and the image viewed through the revolving scanning disc. Such a system is to be recommended with a resistance coupled amplifier. A UX171A power tube should be used in the last stage in such a case.

At B, in Fig. 1, is shown another method of coupling the Kino lamp to the amplifier output. In this system the normal B voltage is used on the last tube and a separate B source in connection with a suitable variable resistor, such as a Television Clarostat, across the Kino lamp to control its brilliancy. The AC component of the plate current of the first audio tube is then fed to the Kino lamp through the regular tone-filter circuit now so generally used in connection with loudspeakers in nearly all types of receiving sets.

A slight modification of this second system was used by me in connection with a push-pull amplifier. The details are given in the circuit diagram, Fig. 2.

#### Correction of Faults

The loudspeaker is shown permanently connected in the circuit. It may, if desired, have a switch connected in series with one of the leads for easy disconnection after the image has been tuned in. There is, however, no necessity of removing the speaker from the circuit, as it will be found to consume very little energy that would otherwise go to the Kino lamp.

The "plate" and the diagonally opposite "filament" contacts of the Kino lamp are the ones to which connection should be made. If, when the tube is connected up and the power turned on, the plate farthest away from the scanning disc glows, instead of the plate nearest, this may be readily corrected by reversing the connection to either the eliminator or battery, as the case may be, that feeds the Kino lamp.

Likewise, if after the image is tuned in and observed through the scanning disc, it appears as a negative rather than a positive, reversing the AC lead will correct the trouble. By a negative image is meant one



# itive by Reversing Leads

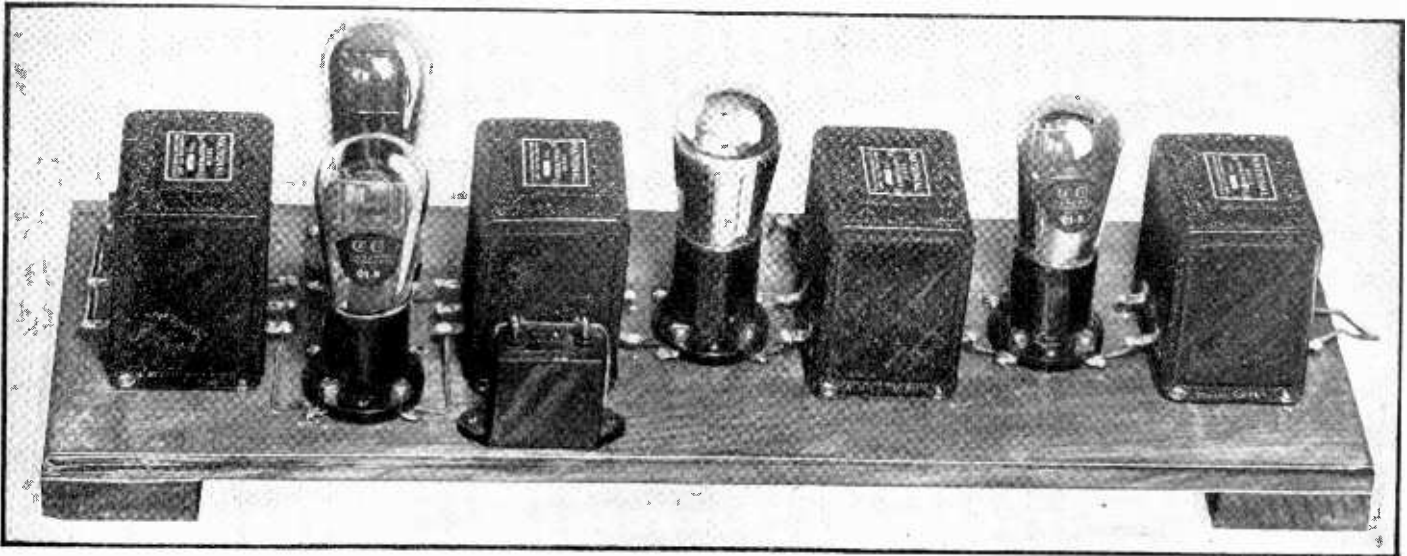

FIG. 6

THE AUDIO AMPLIFIER ALONE. THE SHORT-WAVE RECEIVER FED THIS AMPLIFIER, THE OUTPUT OF WHICH WENT TO THE KINO LAMP. THE FULL SCHEMATIC DIAGRAM IS SHOWN IN FIG. 2.

in which the dark spots appear as light spots and the light spots as dark spots.

### The Scanning Device

The first step to be taken in constructing the scanning device is to build a sturdy framework to support the motor and protect the disc. The arrangement shown in Fig. 3 serves the purpose admirably and has the advantage of being easy to make from readily available materials. The motor is mounted on special rubber vibration-absorption cushions supplied by the motor manufacturer. The disc is then mounted on the motor shaft with the set-screw side of the hub next to the motor. The tachometer, if one is used, is then mounted on the front of the disc hub. Tachometers are quite expensive, although of considerable aid in quickly adjusting the motor speed to the desired value. The tachometer shown in the photograph is a standard Blanchard having a range of from 0 to 1,200 revolutions per minute.

Unfortunately, however, a tachometer of this type lists for \$55, which makes its use in most cases out of the question, as a synchronous motor, costing a great deal less than the tachometer alone, far less the tachometer plus a variable speed motor, is more desirable.

### Induction Motor Used

The reasons for using the variable speed induction motor rather than a synchronous motor are: first, the cost; second, the difficulty of obtaining small synchronous motors at this time; third, elimination of the necessity of gearing the motor to the disc in order to obtain the correct speed; and fourth, the absence of difficulty of shifting disc speeds when going from one station to another.

The synchronous motor, however, has the outstanding advantage of eliminating the necessity of constantly adjusting the speed.

Of the different variable speed AC motors that have been tried, the Baldor, which is a condenser type induction motor, has been found very satisfactory. For speed control, two wire-wound resistors are used in series with one of the 110-volt AC leads. One resistor is of relatively low ohmic value and the other somewhat higher. A push-button switch is connected across the smaller resistor so as to short it out of the circuit when the switch is closed.

The two resistors are then adjusted so

that when the button is released the disc tends to run at just a little less than the desired speed, and when the button is depressed, at a little more than proper speed. Thus, the operator, by pressing the button every few seconds, keeps the disc revolving at the proper speed.

### View Is Your Guide

It is an easy matter to tell when the disc speed is just right, as the image will remain in view only at such times. If the disc speed is too low, a series of images will be seen moving past the window in rapid succession in one direction and if the disc speed is too high, in the opposite direction.

Perhaps a few comments on the disc itself may not be amiss at this time. Contrary to the information contained in some of the recent newspapers and magazine articles, a scanning disc cannot be satisfactorily home-made from a piece of cardboard or, for that matter, even made by the average machine shop. In the first place, the spiral must be very accurately laid out and the holes located in exactly the right spots. A variation of only one one-thousandth of an inch in the placing of one of the apertures is sufficient to show up as a noticeable defect when an image is being viewed.

Then again, the apertures must be square-shaped rather than round if the picture illumination is to be good. That such is the case will be readily appreciated when one stops to consider that the area of, and thus the light transmission through, a square hole is 27% greater than in the case of a round hole of equal diameter. The illumination from the Kino television lamp is not great, and any means of increasing the effectiveness of this illumination by as much as 27% should be given serious attention.

### Enlarging the Image

Still another important detail of a good scanning disc is the counter sinking of the light apertures so as to increase even further the efficiency of light transmission. Thus, while apparently to the layman just a flat metal disc, a good scanning disc is truly a real piece of scientific apparatus into which much engineering and a great deal of skilled work have been put. The National disc, which is the only one combining all of the above features, is made of 1/16-inch thick aluminum, carefully balanced and accurately mounted on a bronze hub with set

screw for fastening to the motor shaft. It is finished in dull black duco.

When using the National 24-inch disc and the Raytheon Kino lamp the size of the image received will be approximately  $1\frac{1}{2} \times 1\frac{1}{2}$  inches. By mounting a magnifying glass in front of the disc, this image size may be doubled so that it appears  $3 \times 3$  inches, without introducing serious distortion.

With the present sources of light it is not possible to obtain an image with sufficient intensity of illumination to permit projecting on a screen, but it is felt that such illumination probably will be one of the early improvements in television. In fact, one theoretical method of accomplishing such results is described by another writer in this issue of RADIO WORLD.

### Operating Notes

While an antenna of the single wire variety having a total length of about 100 feet and located as high and free from surrounding objects as possible, is to be recommended, successful results are obtainable with a much shorter antenna where conditions do not permit of anything better. In fact, the antenna I use in my laboratory at Malden for receiving the Jenkins broadcasts is only 25 feet in length and only 10 feet above the ground.

In some instances a good ground will be found essential while in others best results seem to be obtained without any ground connection. When used, the ground should be connected to the minus A.

While B batteries were used in the early experiments, it was soon found equally satisfactory to employ high-grade B eliminators instead of the batteries in receiving both 3XK and WLEX signals.

### Locate the Signal First

The first step in the reception of a television signal is the locating of the signal on the receiver dials.

The television signal has a very distinctive sound but unfortunately the short waves contain several signals that may easily be mistaken for television. For instance, the high speed code and picture transmission of such stations as WIZ and WQO are very much like a television signal because of the flutter or what may be called a group frequency.

In addition to a low group frequency, which is the rate at which complete pictures are transmitted and which is around 18 or 20 cycles per second, the television signal

(Continued on page 10, column 2)

# Double Lens Proposed for Smaller Disc

By Neal Fitzalan

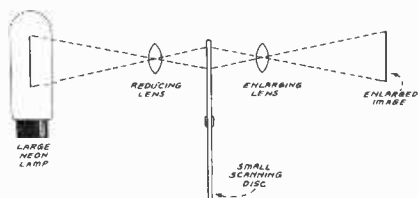

FIG. 1

AN OPTICAL SYSTEM FOR CONDENSING THE LIGHT FROM A LARGE NEON LAMP SO THAT A SMALL SCANNING DISC MAY BE USED AND FOR ENLARGING THE SCANNED IMAGE TO THE ORIGINAL SIZE OF THE LAMP. BRIGHTNESS OF ULTIMATE IMAGE IS NOT REDUCED.

THE size of the received image in a television receiver is limited by the size of the luminous plate of the Kino lamp, that is, if the full intensity of the lamp is to be utilized. If an optical system is used the picture may be enlarged to any desired extent. But as the picture is enlarged the luminosity decreases. If the optical system doubles the linear dimensions of the picture the brightness of it is decreased to one-fourth of its previous brightness because the light available is spread out over an area four times as great.

It is desirable to enlarge the received image at least twice, that is, to make its depth 3 inches instead of 1.5 inches, but it is decidedly not desirable to reduce the brightness of the image. To get a large image with the same brightness as the smaller one it is necessary to increase the luminous area of the lamp in the same proportion as the image area desired.

If the neon lamp is increased so as to get a large image it is also necessary to increase the diameter of the scanning disc in proportion to the increase in linear dimensions lamp or the image. But the scanning disc used for a 1.5x1.5 inch image is already large enough. A scanning disc of 8 or 12 inches in diameter would be much more convenient to one of 24 inches. The question arises how it is possible to use a small scanning disc with a large luminous area.

### Optical System Required

Suppose the lamp is large enough to permit an image of full brightness 3x3 inches and it is desired to use a scanning disc only 8 inches in diameter. How can it be done? By means of a double optical system.

A 3x3 image normally would require a scanning disc of 48 inches in diameter, or 6 times the size of the disc desired. Now it is possible to interpose a lens between the 3x3-inch neon lamp and the 8-inch scanning disc so that an image of the neon lamp is formed on the rim of the disc. The size of this image should be .5x.5 inches. The brightness of this image would be nine times that of the neon lamp, since the linear dimensions of the image are one-third as great as those of the lamp.

Now the 8-inch scanning disc can be used to scan the .5x.5 inch image. A perfectly formed television image of this size against

# Hood Affords

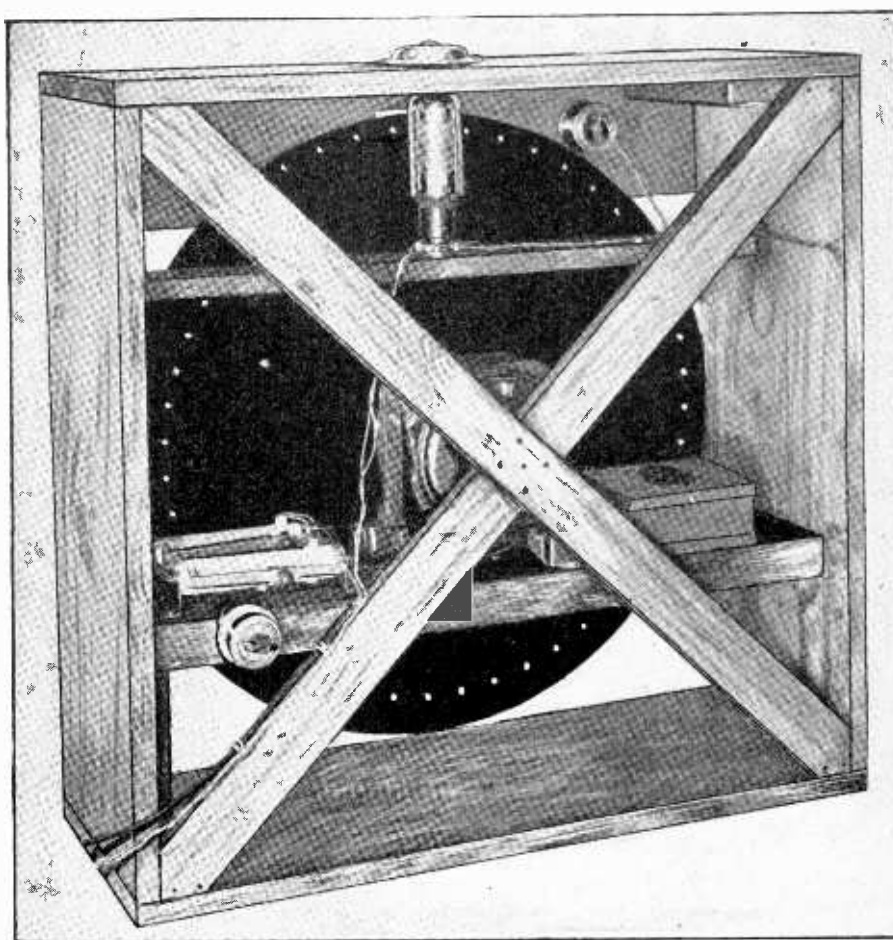

FIG. 7

A STURDY FRAMEWORK SUPPORTS THE MOTOR AND PROTECTS THE DISC. THE MOTOR IS MOUNTED ON RUBBER CUSHIONS TO PREVENT VIBRATION. DIRECTLY ABOVE THE MOTOR, ON A SHELF, IS THE KINO LAMP, TO THE RIGHT OF WHICH, ON THE PANEL, IS THE TELEVISION CLAROSTAT SPEED CONTROL. A LINE SWITCH IS MOUNTED ON THE MOTOR SHELF AT THE LEFT. THE BLACK CIRCLE WITH THE SPIRALLY LOCATED WHITE HOLES IS THE SCANNING DISC.

the spinning disc would be too small. Another lens is necessary to get it back to the original size, that is, the size of the luminous plate of the Kino lamp. This lens would essentially be an enlarging camera which magnified the image six diameters. This enlarged image would have the same brightness as if the large Kino lamp had been scanned with a large disc.

The same method may be used with the ordinary 1.5x1.5 inch neon lamp. A lens may be used to reduce the image of the lamp to one-third so as to make it possible to scan with an eight-inch disc. In that case the enlarging lens would have to enlarge the image on the scanning disc three diameters.

The two lenses used may be identical in design and they need not be expensive, although they should be fairly large so as to gather up as much light as possible. Or they may be of different design. The lens between the neon lamp and the scan-

ning disc may be a couple of 4-inch condensing lenses employed in projection machines. The lens on the observation side may be an enlarging camera or a projection lens, or simply a magnifying glass which enlarges to the desired diameter.

If this system is used it is obvious there is no limit to the size of the scanning disc, for the image can be reduced to any desired dimensions and it can be brought back again to the original size.

The advantages of using a small scanning disc are that it requires small space and that it can be driven with a very small motor. For example, the motor required could be so small that it could be driven directly from the output of a -71A type power tube by an alternating current picked up from the transmitting station for the purpose of synchronization. But these things are for the days to come. There is nothing of the kind available now.

## MILLEN'S MASTERFUL ARTICLE

(Continued from preceding page)  
contains high frequency notes the character of which depends upon the nature and position of the subject before the transmitter.

You will hear a signal that sounds at first

like a flutter and then will note that this flutter is really the rapid repetition of a high frequency note. The nature of this note and its loudness constantly change as the subject before the transmitter moves or

# Clearer View

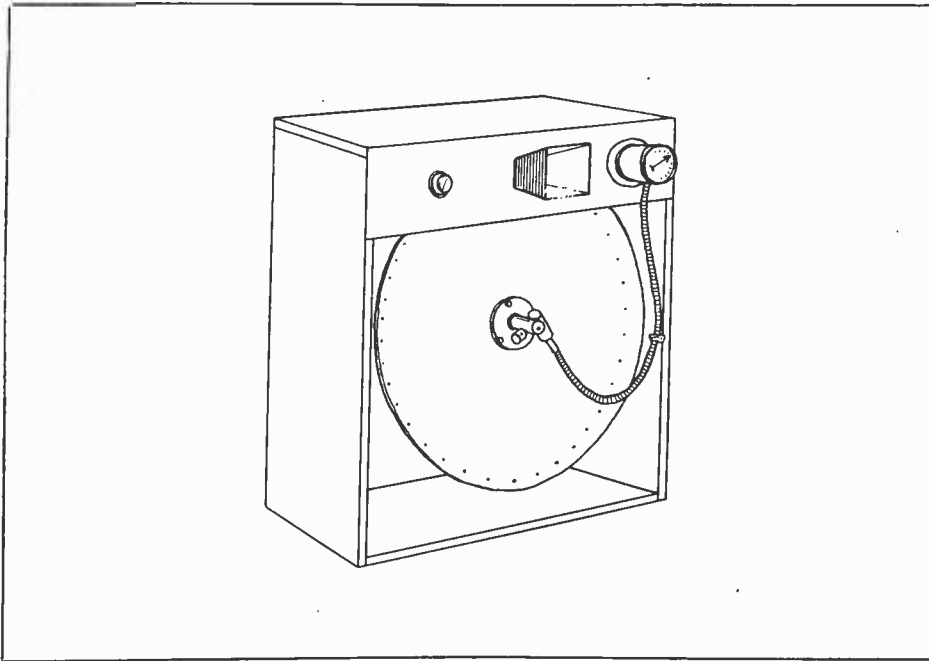

FIG. 8

**HOW A HOOD IS USED AT THE PEER WINDOW TO KEEP OUT UNWANTED LIGHT AND CONSERVE THE LUMINOSITY OF THE SCREEN.**

is changed. For instance, a newspaper rolled up and held in a vertical position produces a distinct note that is very clear-cut. A hand does not produce so clear a note but the signal is of the same general nature.

The television experimenter on his first attempts may be puzzled to find his received picture either turned upside down or else reversed as when you look through a photographic negative the wrong way. Both of these faults can be corrected easily.

### Queer Conditions Remedied

The subject before the transmitter at 3XK is scanned from top to bottom during one revolution of the disc. Accordingly, if you rotate your receiving disc so that the plate of the kino lamp is scanned from bottom to top, the picture will be inverted. To reverse the manner in which the lamp plate is scanned vertically it is necessary either to reverse the direction of rotation of the disc or to remove the disc from the shaft of the driving motor and turn the other side of the disc to the lamp. This operation may involve the removal of the hub and remounting on the opposite side of the disc.

Whether the received image is reversed horizontally is impossible to tell, unless one happens to know the scene being transmitted or something like print is held before the transmitter. For example, at the end of each radio movie broadcast from 3XK the word "end" is transmitted. If you receive this word erect, but reversed, so that the letters read "dne," then your disc is so rotated that the holes pass the Kino plate in the wrong direction.

The correction of this fault is not so obvious. It is plain that whether you scan the plate from top to bottom or from bottom to top makes the difference between the picture being right side up and upside down. Similarly, whether you scan the plate from left to right or from right to left makes the difference between seeing the image correctly or reversed.

### Double Reversal Needed

How can we make the holes pass the plate in the opposite direction and still progress from top to bottom? Reverse the rotation

of the disc around on the shaft of the motor. Thus, if your image is right side up but reversed, you must reverse the direction of rotation of the disc and also remove the disc from the shaft and turn it around with the other side out.

Although these two factors make three wrong combinations and only one correct one, the wrong combinations provide perfectly recognizable images whose worst fault is to be upside down.

Should the image obtained be a negative instead of a positive, the difficulty is due to reversed AC connections to the Kino lamp. Interchanging these connections will correct the trouble.

In our experimentation with the signals of 3XK we have found that the television signal may be almost submerged in noise and yet provide a picture. We find that this information is of interest to those who are already trying to receive the signals from WGY and who, because of the noise caused by day-time electrical disturbances and static, think that reception is hopeless.

It is true that when we are interested in listening to a signal the noise level is an important determining factor but in the case of television the noise level may be high, and, in fact, so high as to make speech transmission hopeless, yet a fair picture can be received. Of course, noise does not help matters. It produces a mottled background and tends to speckle the picture itself. Extreme noise will produce dark lines of varying width across the field of the picture. But in spite of this, the picture is there and since noise is aperiodic unless introduced by vibration from a disc driving motor, the speckle and dark lines are continually shifting their position while the picture remains generally stationary or moves in an orderly fashion.

Accordingly, if in your attempts to receive a television picture you find the signal more or less accompanied by noise, do not judge the noise by sound broadcasting standards but go right ahead and try the signal on the disc. Of course, be sure that the minimum amount of noise is being introduced by your own receiver.

If you are getting a good television signal it will sound very much like a slowly re-

## You Can Get Television At \$50 Cost

By James Millen

The necessary apparatus to receive successfully radio movies and television broadcasts need not be expensive. While the more money one spends—within certain limits, of course—the better the results possible, very good images may be obtained with an expenditure of less than \$50.

In New York City, for instance, where the signals from WRNY are transmitted on the broadcast wave, all that is required, in addition to the family radio set, is a Kino lamp, a motor, a scanning disc and either an extra B eliminator or some B batteries. The 48-hole disc will bring in the signals, as WRNY simply blanks 4 of them. For the preliminary experiments a B eliminator can probably be borrowed from one of the neighbors who is equally interested in "seeing television." Then again, any small variable speed motor may be used rather than the somewhat expensive synchronous motor.

### Foundation Parts

The only parts that really must be of the best quality are the scanning disc and the lamp. The disc, contrary to the impression given out in some recent newspaper and magazine articles, cannot well be made even by the average machine shop, far less by the home experimenter, but must be a very accurately punched, machined and balanced aluminum.

The small 55c neon indicator bulbs being offered by some of the cut-rate radio shops at this time, along with paper or sheet rubber scanning discs, is totally unsuited for television work and it is not fair play to suggest they are any good for this purpose. They are glow lamps for all-night use.

Likewise, in those locations where only the short-wave television signals are receivable, for the first experiments at least, sufficient "junk" may generally be gathered together to form some kind or other of a short-wave receiver and amplifier.

### Lure Is Great

Even with an audio amplifier made up from some old \$2 transformers, recognizable images have been received.

And once even the crudest image is actually seen, it will not be long before the junk goes out and "only the best" of material takes its place, for the television experimenter will encounter even a greater lure to improve his apparatus and keep up to the minute in this new art than did the experimenter of four or five years ago in the early days of broadcasting.

volving circular saw which is slightly off centre. In other words, you hear a high-pitched note which might correspond to the tooth frequency and this is broken up into groups whose frequency corresponds to the rate at which the saw (the disc) rotates. The latter we have referred to as the group frequency, while the high-pitched note is the modulation introduced by the scanning spot. If the disc speed is high and the signal is weak, it may easily happen that the only sound audible in a pair of phones will be the group frequency. Even so, this is no indication that a fair picture cannot be received.

[This ends James Millen's remarkable article, which, however, is only a forerunner. Read next week—issue of September 22—his revelations of new, astonishing television secrets.]

# All Waves on this New

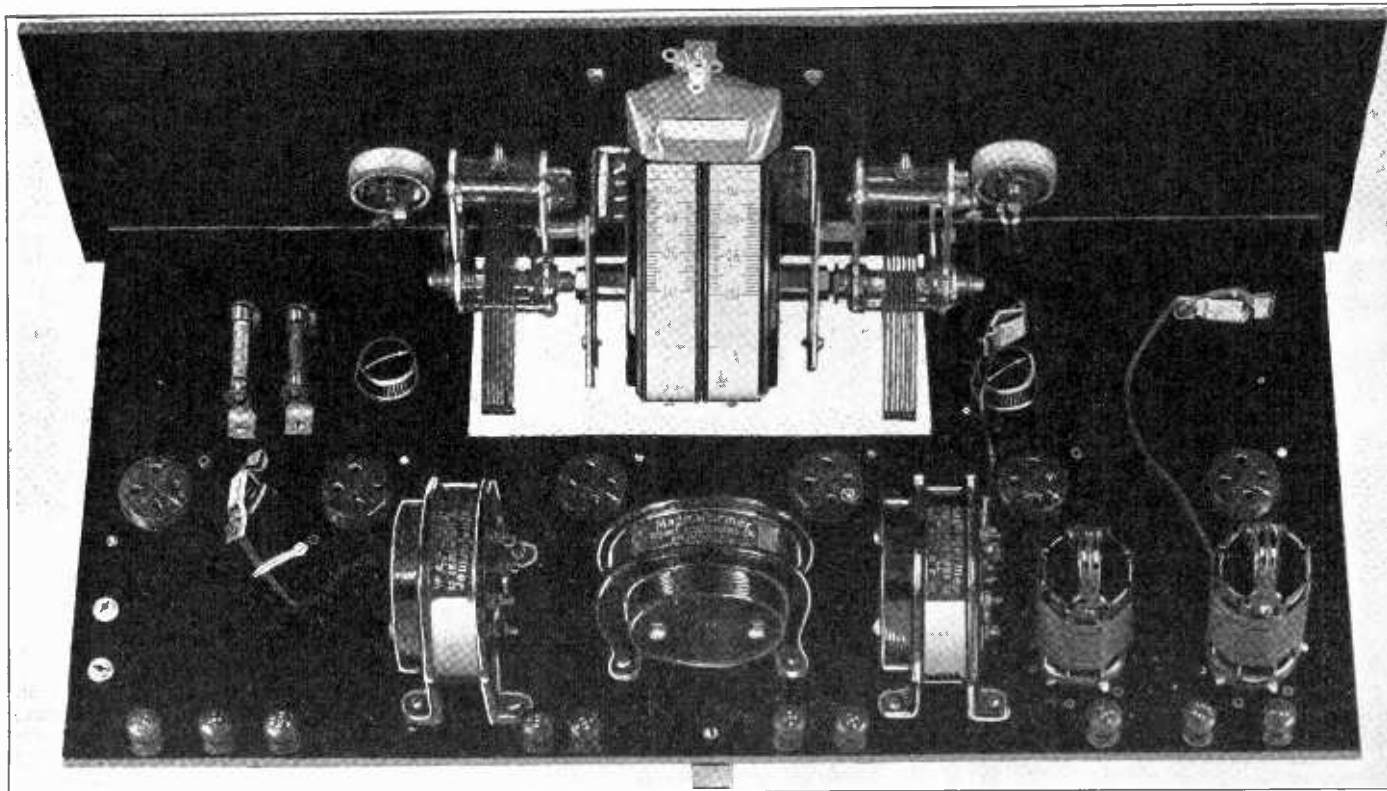

IN THE NEATLY-ARRANGED ALL-WAVE SET ROOM IS LEFT FOR AN OPTIONAL OUTPUT TRANSFORMER (LEFT FOREGROUND).

RECEPTION of broadcast waves and short waves is obtained from this Super Six, embodying an all-wave mixer, using plug-in coils, and operating a speaker with only one stage of audio amplification. That stage is resistance coupled.

Two screen grid tubes are used. One is the first detector, which operates on the negative grid bias system, chosen because it affords the highest selectivity without regeneration. The oscillator is an -01A tube. That brings us to the first intermediate amplifying tube. It is the second screen grid tube.

### High Mu Detector

The second and last intermediate stage has a high mu tube. The second detector is a high mu tube, also, and is operated on the grid bias method of detection. The sole audio tube, and the last valve of the chain of six, is a 112A.

With short wave reception so popular, it is well to have a receiver that will bring in the high frequencies, as well as the broadcast frequencies.

For the broadcast band, however, it is not necessary to change the coils, as you cover all except a few meters at the lower

end of wave group, with a .00025 mfd. condenser.

Since the minimum capacity of the usual .00014 mfd. condenser is about the same as that of the .00025 mfd., you get down as low on the wave scale with .00025 mfd as you would with the other. You get higher waves with the .00025 mfd. All stations come in a little closer together, from the purely physical aspect of dial readings, although the selectivity is no less one way than another. With a .00014 mfd. tuning condenser the short-wave coils used would tune to just under 500 meters, using the largest one of the group of five coils. But with the larger capacity tuning condenser, the 545-meter limit is reached with a few meters to spare.

### An Electrical Blank

The coils, which are of Pilot manufacture, are not used in conventional style. Each coil has three windings. In each of the two instances—modulator and oscillator—one of the windings is not used. In the modulator the plate winding is left unconnected, while in the other the primary winding is an electrical blank. This is because the modulator need be only a radio

frequency transformer, while the oscillator coil must have a large plate winding to produce oscillation. Both coils have their secondaries tuned.

The question then arises how is coupling established between the two?

This is done by placing the coils in mutual inductive relationship. The separation between centers is  $2\frac{3}{4}$  inches.

Such arrangement provides a fixed value of coupling for any given frequency. As the frequency increases the intensity of coupling increases. The same quantity of coupling for the top of the broadcast band would not do for the short waves, so either some degree of varying the coupling would have to be provided, or the amplitude of the oscillation would have to be governable. The oscillator was chosen for variation, and the rheostat in its negative leg is used for controlling the intensity of the oscillation. This is a good thing, because too strong an oscillation on broadcast locals will overload the first detector. This rheostat, therefore, is a sensitivity and quality control, as well as a means of making short wave reception practical.

### Fading Eliminator

It will prove a surprise to many, including some who have had much practical experience with intermediate frequency amplifying systems, that the degree of oscillation in this tube has such an important effect. A practical demonstration was given in my home one recent evening, when WGY was tuned in. With an arbitrary 5-volt filament voltage on the oscillator the station came in weakly, but when the voltage was reduced to 4, the signal strength more than quadrupled. Other stations in the broadcast band came in better when the setting was other than 4 volts.

Incidentally, WGY was held without fading. This type of circuit, if sensitive enough at the intermediate level, is a good fading-eliminator, since a very weak signal at the input still will leave enough at the second detector to afford a good signal. The

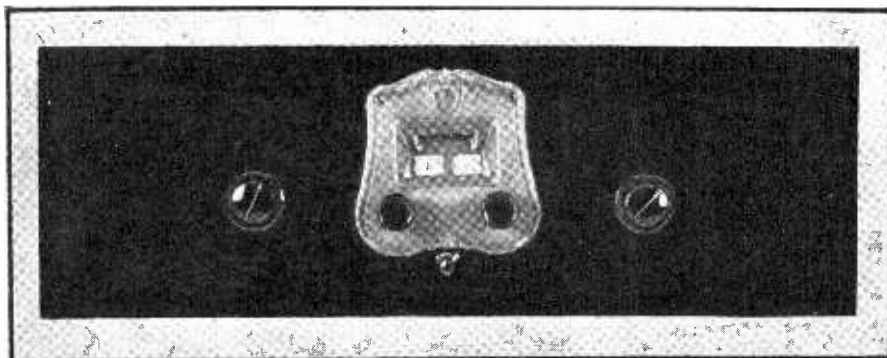

EASY TO TUNE? LOOK AT THE FRONT PANEL!

# Super Six Receiver

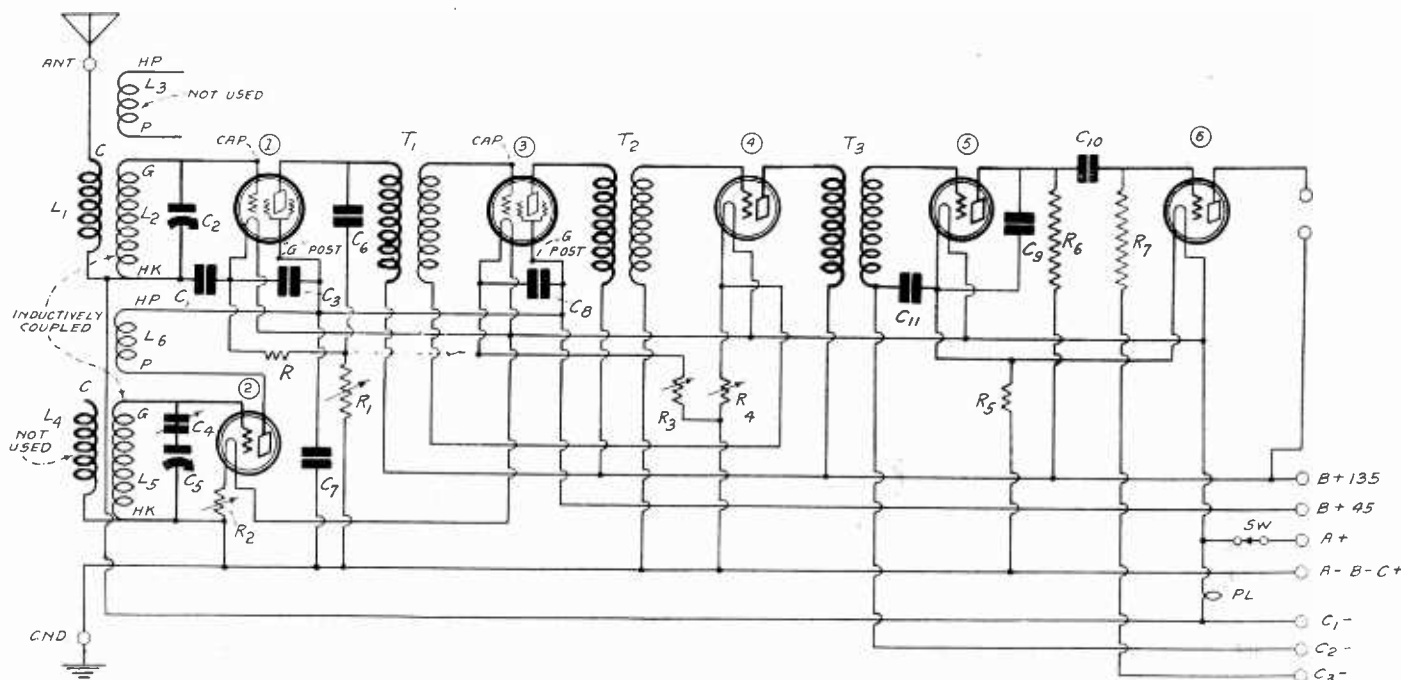

THE CIRCUIT IS A SIMPLE ONE. ANYBODY CAN BUILD IT.

intermediate channel always will amplify to the same extent, hence the varying strength of the carrier is effective only on the first detector. WGY, in its fading, might swing from a maximum relative value of 100 to a minimum value of 1, and nobody in the room would notice the difference, because there would be good audibility all the while. If you call attention to WGY's weakness and everybody listens with especial care, of course the difference is noticeable. But the signal is heard plainly all the while—which is not true of reception of WGY on any other type of receiver in the aforementioned locality. KDKA, another bad fader, was held to good audibility for an entire evening, on three different wavelengths, two of them short waves.

## Voltages Proportioned

Anybody familiar with intermediate frequency circuits wants to know immediately if the intermediate channel oscillates. This one can oscillate, like almost any other, but the voltages should be so proportioned that no oscillation will take place. The filament voltage of the first intermediate amplifying tube, a screen grid valve, is made 3.3 volts, or a little less, by setting the subpanel rheostat. The voltage on the screen grid (G post of socket is critical, if you use a B eliminator, only because the variable resistors commonly supplied with such eliminators do not vary smoothly in small, gradual steps, and moreover, few persons know just what the voltage is.

A high resistance voltmeter is necessary for this determination, although for purposes of operating the receiver you do not care particularly what the voltage is, so long as you can turn the knob toward lower voltage values until the best results are obtained. There will be squealing until this point is reached. Do not turn the voltage to higher values to stop the squeal, for, although you will succeed in stopping it, you will reduce the sensitivity considerably by overvoltage and will reduce the tube life.

A high mu tube is used as the second intermediate amplifier because it builds up the signal more than an ordinary tube, especially if intermediate transformers of a large-winding primary type are used, as in

this instance. The intermediate transformers, three of which are used, since there must be one extra to couple to the second detector, are Magnaformers, manufactured by Radiart Laboratories, Chicago. Their frequency is a trifle less than 70,000 cycles. Their amplification per stage is high, and when used with screen grid or high mu tubes is exceptionally high.

The amplification at the intermediate frequency level is high enough to make stations that are weak on tuned radio frequency sets sound just as loud as strong stations, for the same reasons that fading is practically eliminated. Antenna signal strength is very important in the TRF circuits, but not important in intermediate

frequency circuits like this one, since the chain is responsive to very, very weak impulses.

That is why some people remark disparagingly that an intermediate frequency circuit brings in WOR, for instance, no louder in New York City—where it is the loudest station—than does a TRF set of fewer tubes. That is often true. But the other side of the picture is that the intermediate frequency circuit picks up very weak signals, makes them loud enough to hear and enjoy, when the TRF circuit misses them.

The amplitude is high enough in the present circuit to operate a speaker on only one stage of audio, due to the design of the Magnaformer coils, the use of the screen grid and high mu tubes at the intermediate level, and resistance as the audio coupling between second detector and power tube. The plate resistance of the high mu tube is so high that the effective voltage development in the detector is by the square law, whereas a low mu tube as second detector, with resistive plate load, would bypass much of the signal strength.

## Bias Used

The first detector is worked at 1½ volts negative bias from an external battery, plus the drop in the filament resistors. There is a fixed resistor in the negative leg, of 20 ohms, to give the screen grid tube a maximum of 3.3 volts making a total negative bias of 3 battery volts plus 2.7 resistor-drop volts, a total of 5.7 volts. This is diminished somewhat by using the rheostat, since the current is reduced as the useful resistance of the rheostat is increased, hence the bias is reduced.

This makes the rheostat play a unique part as a volume control. Principally, that rheostat is used for volume control and preventing oscillation in the first detector on short waves. But it sometimes happens that for a small part of the rheostat's range, increased resistance, lower filament temperature and lower bias, will increase the volume, because lower bias may work this tube better.—Herman Bernard.

[Other absorbing phases of this circuit will be discussed next week, issue of September 22d.]

## LIST OF PARTS

L1L2L3—L4L5L6—Two sets of Pilot plug-in short waves coils; ten coils, 15 to 545 m.

T1, T2, T3—Three Magnaformer intermediate frequency coils.

C2, C5—Two Pilot .00025 mfd. tuning condensers.

C1C1, C3, C8, C9, C11—Six .00025 mfd. fixed condensers

C7—One .006 mfd. fixed condenser

C10—One 1.0 mfd. bypass condenser

R—One 20-ohm fixed resistor

R1—One 30-ohm rheostat Pilot (for front panel)

R2—One 6-ohm Pilot rheostat (for front panel)

R3—One 30-ohm Pilot rheostat

R4—One 6-ohm Pilot rheostat

R5—One 2-ohm fixed resistor

R6—One .5 meg. Pilot fixed resistor

R7—One 2 meg. Pilot fixed resistor

1, 2, 3, 4, 5, 6—Six Pilot subpanel (button type) sockets; two type UY, 5-prong sockets, extra, for coil receptacles

SW—One A battery switch

Eleven binding posts

One Pilot double drum with pilot light socket for pilot light PL

One 7-21-inch front panel

One 10x20-inch subpanel

Two tip jacks

Tubes: two screen grid 222 two high mu 240, one 201A and one 112A

# 2,508,800 Amazing of Bernard's

By Herman

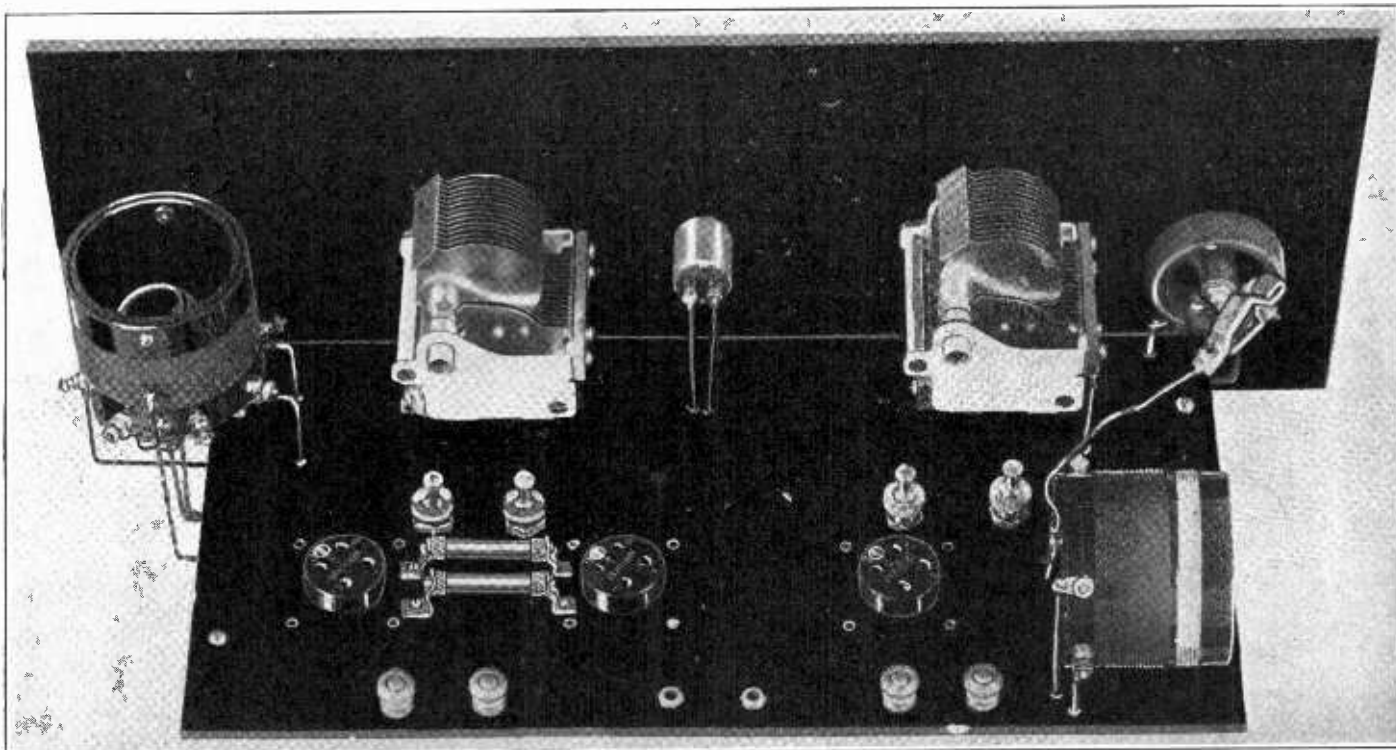

FIG. 1

HERE IS THE ECONOMY THREE WITH A VERY INTENSIVE ANTENNA PICK-UP AND A SHORT-WAVE DEVICE BESIDES. THE COILS REMAIN IN PLACE ALL THE WHILE. SUBPANEL SWITCHES AFFORD SOME SHORT-WAVE TUNING. THE ANTENNA COIL IS A CONTINUOUS WINDING, SINCE TWO SECTIONS ARE JOINED CONDUCTIVELY.

HERE is a three-tube circuit you can not easily believe will work splendidly and loudly, by mere glance at the diagram, one that even tried engineers have blinked at with dubious eyes, only to be convinced it certainly produced results.

It can be built up at a cost of about \$29, including tubes, but not including cabinet.

The circuit is the Economy Three, of which some theoretical discussion and constructional information have been published, but the circuit is now shown with the additional advantages of short wave reception and simplified tuning on lower broadcast waves.

#### Six Outstanding Points

A synopsis of the features of this receiver follows:

- (1) Operation of a speaker, with only one stage of resistance coupled audio.
- (2) Sensitivity and selectivity surpassing that of the usual run of five-tube sets.
- (3) Usual broadcast band tuning, with the addition of reception of short waves without changing coils.
- (4) Simplified tuning on the lower broadcast wavelengths and also on the waves below 200 meters.
- (5) Finest audio quality possible with moderate B voltage, due to use of grid bias detection and to absence of audio coupling distortion.
- (6) Low cost of parts, equipment and upkeep.

The fact that this circuit operates a

### Circuit Can Be Built for About \$29, Including Tubes, but Not Cabinet, A, B and C Supplies—Six Outstanding Advantages

speaker, not merely fairly well, but excellently, has occasioned considerable surprise, because, it is pointed out, there is only one stage of audio frequency amplification, and it is resistance coupled, which is not reputed to give high enough gain per stage.

But the use of a high mu tube as detector, with suitable plate resistor, of .1 meg., gives a gain equal to that furnished by a low-ratio transformer working out of a conventional detector tube.

The problem lies rather in another direction—that of providing suitably large input to the detector so that the detector output will give adequate voltage to the grid of the sole audio tube used.

The degree of amplification ascribable to the detector is not at stake, for with a high mu tube the square law applies even at large volume, and the difficulty would be to get a sufficiently high input to the detector so that the square of that

input would equal the negative grid bias of the audio tube.

Assuming, therefore, a negative bias of 9 volts applied from a C battery to the last tube, 112A, the maximum detector input would have to be the square root of that bias, or 3 volts.

#### Amplification Analysis

The amplification of the circuit is analyzed as follows:

Constant	Step-up	Total
Antenna coupler	1-to-4	4
Screen grid tube	1-to-70	280
Interstage coupler	1-to-2	560
High mu detector tube	square	313,600
Audio tube (112A)	1-to-8	2,508,800

The total of 2,508,800 is without benefit of regeneration. In a stated instance, at 1,000,000 cycles (300 meters), a .01 volt output at the detector was increased to 1 volt by the aid of regeneration. This is an amplification of 100.

However, no general figure can be given as representative of the boosting effect of regeneration, since regeneration operates on the law of the two-thirds power of the ratio of the grid space to the amplitude without regeneration.

The grid space is the grid voltage change necessary to bring the plate current from zero to saturation. The law of applied regeneration is of an inverse signal strength ratio. On strong signals the tickler has little or no effect. The weaker the signals, the greater the benefit of

# Total Amplification Economy 3

Bernard

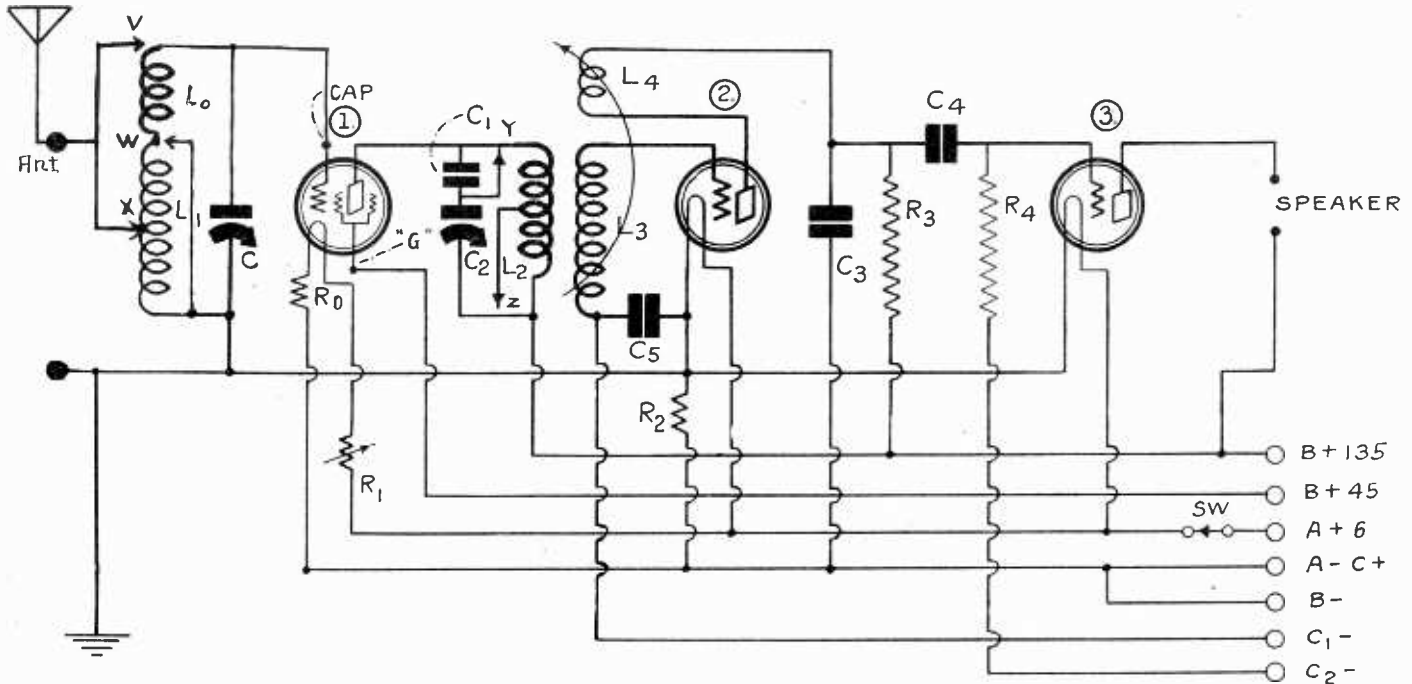

FIG. 2

THE ECONOMY THREE, FOR SHORT AND BROADCAST WAVELENGTHS, WITHOUT USE OF PLUG-IN COILS, IS SHOWN DIAGRAMMATICALLY ABOVE, FOR THE FIRST TIME. HALF OF ONE OF THE TWO TUNED INDUCTANCES IS SHORTED OUT FOR WAVES BELOW THE BROADCAST BAND. THE TUNING IN THIS RANGE IS SIMPLIFIED BY THE SERIES CONDENSERS C0 AND C1. THIS CIRCUIT WORKS A SPEAKER ON ONE AUDIO STAGE.

regeneration. Also, the higher the frequency, the greater the regeneration.

### Figuring Explained

In the tabulation above, the term step-up is applied to all forms of increase, as this is quite permissible simplification. It is usual to refer to the step-up of mutual inductive coupling and the mu or amplification factor of a tube, but in either instance a given quantity is multiplied by a stated number.

The screen grid tube is figured at a seventy-fold increase, but it is well understood that this is not a constant. As the frequency increases, the effective amplification increases, and 70 is used simply because that was the working mu of the tube at the geometric mean of the broadcast band (910 kc, 330 meters).

Obtaining a 1-to-2 step-up in the inter-stage coupler, which is a Screen Grid coil, affords a novel advantage, since the best heretofore obtainable was a 1-to-1 ratio. This is the first commercial coil to provide a step-up when coupling a screen grid tube to its successor, while still having a full-impedance primary. In the present circuit the primary of this coil is tuned.

The absolute square of input is used for calculating the detector output because of the high mu tube's detecting efficiency, although the output is admittedly proportional to the square of the input, not often absolutely the square.

### Meets Requirements

To determine whether any circuit, with an amplification of 2,508,800, can

## Screen Grid Tube as Radio Amplifier Worked at Step-up of 70—New Coil Design Contributes to Circuit's Great Success

operate a speaker, calculate from the output tube forward. The 112A, at a plate voltage of 135, requires a negative bias of 9 volts. This is the maximum allowable signal voltage swing across the audio grid leak. The mu (8) of the 112A tube accounts for a 72-volt swing at the output. Dividing 72 volts by 2,508,800, we get .00003 volt, or 300 microvolts.

Assuming an average antenna of 5 meters elevation (16.4 feet), the broadcast wave's voltage in the antenna need be only 60 microvolts per meter. Field strengths of 50 to 100 millivolts per meter are as strong as are desirable from a station's viewpoint, in computing its regular service area. Even a poor set is good enough to pick up a signal of that strength and reproduce it well on a speaker.

### Improved Selectivity

The foregoing detailed tabulation and exposition account for the fact that this set operates a speaker on only one stage of audio, and show that such performances are not remarkable. The unusualness

### LIST OF PARTS

- L0L1—One Screen Grid Antenna Coil. (Model 2A)
- L2L3L4—One Screen Grid three-circuit coil, with step-up ratio. (Model 5HT)
- C, C2—Two .0005 mfd. variable condensers.
- C1, C5, C3—Three .00025 mfd. fixed condensers.
- V, W, X, Y, Z, SW—Six switches.
- R0—One 20-ohm fixed resistor.
- C4—One .01 mfd. fixed condenser.
- R1—One 10-ohm rheostat.
- R2—One 2-ohm fixed resistor.
- R3—One .1 meg. metallized resistor (Lynch.)
- R4—One 5 meg. metallized fixed resistor (Lynch.)
- 1, 2, 3—Three sockets.
- Speaker—Two tip jacks.
- One 5-lead battery cable.
- Four binding posts (Ant., Gnd., two C—).
- One 7x18-inch front panel.
- One 7x14-inch subpanel.
- Two dials.
- One knob for tickler to match rheostat knob.
- Four subpanel clips for mounting R3 and R4.
- One screen grid tube, one 240 high mu tube and one 112A tube (Harmonique.)
- Two subpanel brackets 1-inch high.

is wholly centered on the fact that the most logical application of the screen grid tube as a radio amplifier, working into a  
(Continued on page 10, column 2)

## How to Wind The Coils For 3-Tube Set

The usual number of turns prescribed for coils to tune with .0005 mfd. condensers will not apply to the Economy Three, because a screen grid tube is the radio frequency amplifier, and has a low input capacity as compared with the detector tube, and also because the coil used for coupling to the detector has a large secondary, causing an increase in the inductance in the primary due to mutuality.

The diameters used for the antenna coil and the primary of the high impedance three-circuit coil are 2½ inches outside measurement. No. 24 single silk covered wire or equivalent is used on all windings except the tickler.

### Antenna Coil

For the antenna coil, wind 57 turns, tapped at the fourteenth and the thirty-eighth turns. This will give you four terminals.

The first is the beginning of the winding and goes to grid of the RF tube.

The fourteenth-turn tap is used as an untuned input for short waves.

The third terminal is the aerial connection, which goes to the thirty-eighth turn tap.

The fourth and last terminal is the end of the coil and goes to ground. The tuning condenser across the fourteenth turn, when short waves are sought, is set at minimum capacity, and all tuning is done exclusively with the detector tuning condenser.

### The Tuner Coil

The three circuit coil has a primary of 39 turns, wound on the outside of the 2½-inch diameter. The secondary is on a tubing 2 inches in diameter and has 60 turns. This coil is placed inside the primary tubing. The tickler has 20 turns of No. 22 double silk covered Litzendraht wire. This wire is used for its flexibility, so that no amount of tickler turning will injure the tickler wire lead-outs in any way. Besides, the tickler is provided with an end-stop. The tickler form is 1½ inches outside diameter.

It will be noticed that despite the conductive coupling of the antenna to the screen grid tube, the number of turns on the antenna coil is larger than would be expected, and also the number of turns on the primary of the three-circuit coil is smaller than would be expected. However, the inductances provided in the manner stated worked out best in actual practice, commercial coils being used in the experiments.

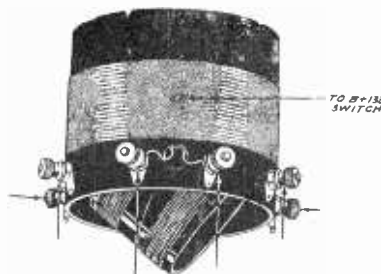

**THE TUNER IS MOUNTED UPSIDE DOWN. LOOKING AT THE COIL FROM THE REAR, WITH SHAFT AWAY FROM YOU, THE BINDING POSTS ARE, LEFT TO RIGHT, DET. C-, G, TICKLER, TICKLER, P AND B+135**

(Continued from preceding page)

grid biased high mu detector, using only one audio stage, received no attention from circuit designers. However, it has been a pleasure to show the way.

Sensitivity and selectivity are adequate. The amplification shows the sensitivity to be excellent, while the stage of tuned radio frequency and regenerative detector are well known for their good selectivity.

In the present circuit more than the average results are safe on the selectivity score, because the grid bias method of detection assures greater selectivity. There is no grid current and no grid leak to dampen the circuit.

The tuning throughout the broadcast range is of the familiar type of tuned radio frequency.

For the lower broadcast waves, if desired, and for the shorter waves that will be tuned in a series condenser (Y) may be cut in by opening the short-circuiting switch put across it on the subpanel.

This series condenser is .00025 mfd., of the fixed mica type, and it provides a capacity range in the tuning condenser of from .00005 to .000167 mfd. This gives a fine spread-out.

For instance, the series condenser cut in, the tuning range with the Screen Grid Tuner's, full windings, is from 187 to 370 meters. That means the full scale of the dial is used to tune in the lower half of the wavelength spectrum. The effect is to bring in a much greater number of distant stations, and without trickiness of tuning.

Of course on shorter waves the advantage of this spread-out is still greater.

The series condenser, however, does not increase the tuning range or get lower-wave stations, since the minimum capacity is about the same. The maximum and intermediate points are reduced.

The shorter wavelengths—those beneath the broadcast band, under 200 meters—are tuned in by working four other subpanel switches. These switches when closed short-circuit a generous part of the antenna coil and primary of the interstage coil. Thus the wavelength that can be reached is materially reduced. A midtap will bring you down to 126 meters, but a lower tap will carry you lower.

## Dials Read Alike When Coils Match

The dials of the two tuned circuits may be made to read alike throughout the broadcast band, with minor discrepancies, if the inductances are properly proportioned.

### Dissimilar Windings

The antenna coil ordinarily tends to give higher dial readings than the other, but this point is corrected by having dissimilar number of turns on the winding of the Screen Grid Antenna Coil and the primary of the High Impedance Tuner.

The commercial coils provide equal dial settings, and as the advantage of keeping dials in step serves convenience it is well enjoyed by experimenters.

If there should be dissimilar tuning you can correct it easily in either or both of two preferred ways, although there are several other methods.

### Correction Methods

Let us state a problem first.

If the antenna tuning condenser reads lower than the other by 5 degrees at or near the middle of the dial, then you can circumvent this effect by placing a .00025 mfd. fixed condenser in series with your antenna lead.

The antenna is disconnected from the binding post, and instead one side of the series condenser is put there, the other or open side of the series condenser going to the otherwise unconnected aerial lead.

Having demonstrated the satisfaction of this method, you can solder the series condenser in place, between the antenna binding post and the thirty-eighth turn tap on the coil.

### The Opposite Problem

If the detector tuning condenser gives too low readings, as compared with the other, remove turns from the secondary. In some instances, where the difference is about 7 degrees near the high numerical end of the dial, the inequality can be remedied by removing four turns. If primary, or outside winding of the tuner has 48 turns instead of 39, simply remove the twelve turns. This is easily done.

Snip the wire where it goes to the B plus binding post of the primary, which is near the front panel, and hold the wire so it does not spring away from the form. Remove the four turns, tighten against the remaining wire, push back some of the insulation, solder directly to the empty lug without passing the wire through the form. This little trick takes just three minutes by the watch, soldering and all.

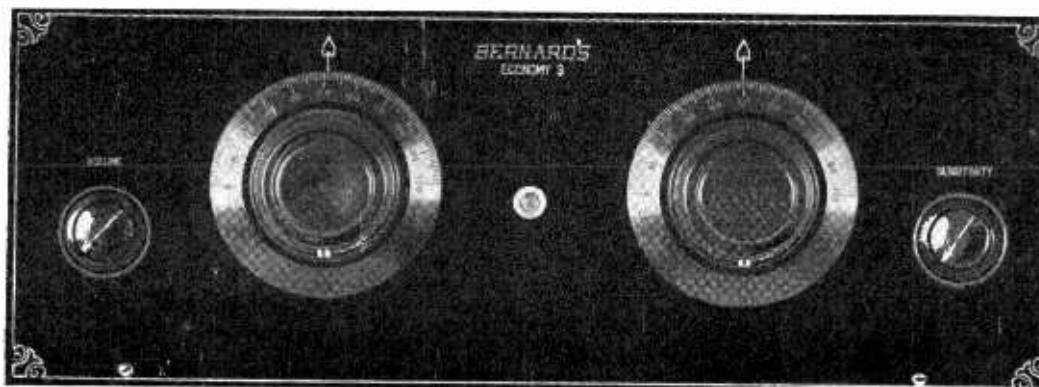

FRONT PANEL VIEW



# Push-Pull Explained

By Herbert E. Hayden

**P**USH PULL amplification is constantly gaining in favor with radio fans. The reason is that as soon as they hear the performance of a good push-pull amplifier they immediately recognize something superior, something just a little more realistic than they have heard before.

And as more and more people become interested in the performance of such a circuit they also desire more knowledge of its principles of operation. What makes it push and pull? Why is the output relatively free from harmonic distortion? Why do the outputs of the two sides of the circuit add up in the loudspeaker? Why don't the outputs neutralize each other? Why is this circuit not so much subject to motorboating and kindred troubles? Why is it less subject to hum when operated on a given B battery eliminator? These are some of the questions asked.

### Two Men Sawing a Log

The term push-pull has been applied to the circuit for lack of a more descriptive name. But for all its lack of descriptiveness it is a good name which in a way suggests the action. It might also be called the see-saw circuit.

The operation might be likened to the action of two men sawing a log with a cross-cut saw. Neither of the two men pushes the saw, at least not experienced sawyers. Each takes a turn pulling the saw. If they push the saw bends, which introduces distortion both in the saw and in the cut.

In a push-pull circuit the two tubes take turns doing the heavy work. Whether they push or pull depends on the point of view. It might be said they take turns drawing power from the plate battery. And if the circuit and the two tubes are well matched, one tube will relinquish the drain at the same rate that the other demands it, so that there is no change in the amount of current drawn from the battery or power pack. It is that fact which accounts for many of the advantages of the push-pull circuit. If the current drawn from the voltage source is not constant the circuit is not truly push-pull.

### How It Works

The operation of the circuit may be explained by the aid of the simple drawing in Fig. 1. Resistances are used both in the input and the output of the circuit because they make the explanation clearer.

Resistances R1 and R2 are supposed to be equal in value, as are the resistances R3 and R4. The two tubes 1 and 2 are supposed to be equal as to amplification factor and mutual conductance. Both are heated by the same filament battery A. The operating point of each circuit is determined by the grid battery C, and the same voltage is applied normally to both the plates by means of battery B.

Suppose at first that the battery E1 is not connected. The plate currents in the two tubes are then determined by the grid bias supplied by C, by the plate resistors R3 and R4, and by the plate battery B. Let these plate currents be indicated by I3 and I4. Since the tubes are equal these two currents are equal in magnitude but opposite in direction. That is, both flow away from the junction of R3 and R4 toward the respective plates. The steady voltage drop in R3 is R3I3 and the steady drop in R4 is R4I4. The sum of these voltage drops is the output voltage E2. This sum is zero since the two addends are equal in magnitude and opposite in di-

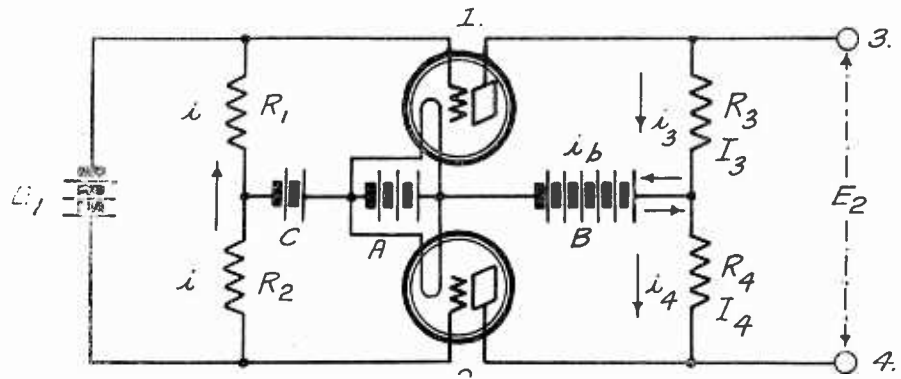

FIG. 1

A DIAGRAM OF A ONE-STAGE PUSH-PULL AMPLIFIER ILLUSTRATING THE MANNER IN WHICH THE PUSH-PULL PRINCIPLE WORKS.

rection. That is, when there is no input voltage there is no output voltage.

Now let the battery E1 be connected with the polarity indicated. This will send a current through R1 and R2 in the direction indicated by the arrow. If this current be  $i$  amperes the voltage drop in R1 is  $iR1$  and the drop in R2 is  $iR2$ . These drops are equal since the resistances are equal. But they are opposite in direction with respect to the grids. The bias on tube 1 will be increased by  $iR1$  and the bias on tube 2 will be decreased by  $iR2$ .

### Changes Add Up

The plate current of tube 1 will be decreased by an amount  $i3$  and the current in tube 2 will be increased by an amount  $i4$ . The new current in R3 will be  $I3-i3$  and the new voltage drop R3 ( $I3-i3$ ). The new current in R4 will be  $I4+i4$  and the new drop will be R4 ( $I4+i4$ ). These are no longer equal in magnitude, but they are still opposite in direction with respect to the junction of R3 and R4. The algebraic sum of the two is the value of E2. But the algebraic sum is the arithmetic difference between the two, and this is  $R3i3+R4i4$ . Thus the steady voltage drop between points 3 and 4 cancels out just as it did before, but the voltage drop changes add up. The reason the voltage changes add up is evident from the fact that the current changes  $i3$  and  $i4$  are in the same direction through the resistors, a fact indicated by the arrows.

There is no change in the current through the battery B for the two current changes are equal and in opposite directions in the battery.

The voltage of the battery E1 was divided equally between the two tubes. After amplification the effects add up in resistors R3 and R4 so that the value of E2 is equal to E1 times the amplification of either tube.

### Effect of Reversal

Now suppose that the battery E1 be reversed. The current  $i$  changes direction. So do the voltage changes on the two tubes as well as the current changes  $i3$  and  $i4$  in the output resistors. The output voltage E2 also changes direction.

If an alternating signal voltage be inserted in place of E1 a magnified voltage will appear across terminals 3 and 4 in the same way that the steady voltage changes appeared across the terminals when the battery was in the circuit, for at any instant a current will flow in R1, R2 in one direction or the other, causing changes in the grid voltages. E1 may be the voltage induced in the secondary of a transformer

in the primary of which a signal current is flowing.

R1 and R2 need not actually be resistors. They may be the halves of a mid-tapped secondary of a push-pull input transformer.

Likewise R3 and R4 need not be resistors. They may be the two halves of a mid-tapped choke coil, or the halves of the primary of a push-pull output transformer, or two halves of the armature winding in a loudspeaker.

The grid voltage changes produced by the battery E1 or by the transformer winding substituted for E1 are the first harmonic of the signal, or the fundamental. An amplified output voltage appeared across terminals 3 and 4. The steady bias caused by C which acted equally produced no voltage across these terminals. This steady voltage may be called the zeroth harmonic. This is even mathematically. The first is odd.

Each of the tubes introduces harmonics of both even and odd degree, due to the curvature of the output characteristics. Thus not only the zeroth and the first harmonics are present but the third, fourth, fifth, and so forth.

### Even Harmonics Out

It may be shown that the current changes of even order flow in the resistors R3 and R4 in the same direction as the steady current, or the current of zeroth order. Also it may be shown that all current changes of odd degree flow through these resistors in the same direction as the first harmonic. Hence there will be no voltage across terminals 3 and 4 corresponding to even harmonics, but there will be voltage across them for all the odd harmonics.

Thus the push-pull amplifier prevents the development of all even harmonic voltages. The term "prevents" is used advisedly for the balanced circuit does not eliminate them. The push-pull amplifier does not prevent the development of odd order harmonics.

If the tubes are loaded properly all harmonics of higher order than the fourth are negligible. Even the third will be very small, provided that the tubes are not overworked.

### Effect of Impedance in B

Since the push-pull circuit prevents the development of harmonics of the second and fourth degree, there is only the third left which will cause appreciable distortion. With proper operation of the tubes this will be less than one percent of the intensity of the first harmonic, or the signal. Therefore the well balanced push-pull am-

(Concluded on page 30)

# A New Push-Pull

By J. E. Technical

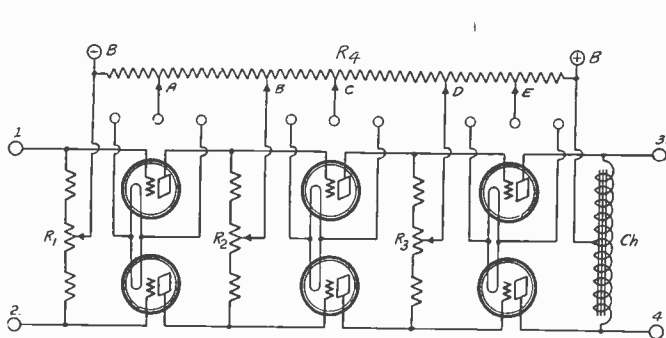

FIG. 1

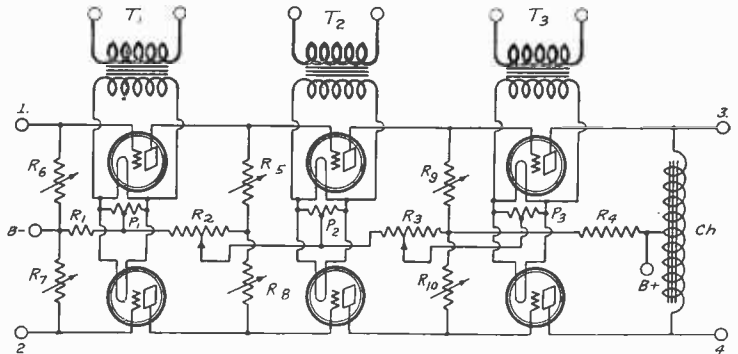

FIG. 2

CIRCUIT DIAGRAMS OF TWO THREE-STAGE PUSH-PULL RESISTANCE COUPLED AMPLIFIERS IN WHICH NO STOPPING CONDENSERS ARE USED BETWEEN STAGES.

## First Presentation of a Circuit that Omits Grid Stopping Condensers, Grid Leaks and C Batteries and Reduces Hum and Common Coupling Between Stages — Great Gain on Low Notes

### PART I

IN the June 11th, 1927, issue of RADIO WORLD the writer published a three-stage, push-pull resistance coupled amplifier which had certain remarkable properties. It was possible to operate that circuit with unfiltered plate voltage without any resulting hum. When the circuit was reasonably well balanced there was no motorboating, although each half of the circuit motorboated violently when used alone.

Due to the fact that it is impossible to balance a circuit like that so well that one side is the mirror image of the other, the residual unbalance produced a peculiar effect. The feedback which causes motorboating in a single-sided circuit caused a reduction in the volume on one side and an increase on the other. Hence although

the input to both sides of the circuit was the same, the output differed considerably. To equalize the two it was necessary not only to balance the coupling devices, but also to select tubes in pairs which had equal characteristics.

Even with all these precautions there was some unbalancing noticed.

Even so, the balance was sufficient to eliminate hum and actual motorboating when no filter was used.

### Effect of By-Pass Condenser

When a large condenser was put across the voltage source most of the cumulative unbalance was removed and the circuit operated satisfactorily. Many who built the circuit reported splendid quality.

One of the difficulties of a resistance coupled push-pull circuit is to couple it to the detector without the use of a trans-

former. Many push-pull resistance coupled circuits appeared in the radio press some time after the circuit appeared in RADIO WORLD and all of these were coupled to the detector directly in such a way that only one side of the push-pull circuit was active. The other side was grounded both at the filaments and at the grids, so far as the signal was concerned.

There seems to be no simple way of coupling a detector to the push-pull amplifier, except by means of a transformer, which is not subject to this difficulty.

Possible methods of coupling will be discussed later and their disadvantages pointed out.

The subject of this article is not the resistance coupled push-pull circuit which has been published already, but a new development of it. Readers of RADIO WORLD will recall an article on direct coupled circuits without stopping condensers was published in the July 28th issue, as well as in other issues, a number of articles on performance characteristics of resistance coupled amplifiers. These were the result of studies made on a special direct coupled circuit which will now be discussed.

### New Circuit Development

In October, 1927, G. H. Paris of Duluth, Minn., wrote to RADIO WORLD for criticism of a novel impedance coupled push-pull circuit in which no stopping condensers were used between tubes. It appeared to be a radical departure in circuit design and one capable of unexcelled quality.

Some time after this circuit came to the writers' attention there appeared a series of articles in a Swedish radio journal on a circuit attributed to an English writer named Johnston. The system of amplification has accordingly been called the Johnston system. It has appeared once in an American magazine, described by A. Dinsdale, an English radio writer well known to American readers.

In the Johnston system the filaments are connected in series with high resistances placed between the filaments to obtain a suitable plate voltage from the resistance drop. The connection makes it possible to dispense with the stopping condensers between the tubes.

### Paris Circuit Similar

The circuit proposed and used by Mr. Paris works on essentially the same principle as the Johnston circuit, but it differs considerably in detail. It is push-pull, for one thing, and it is not limited to series connection of filaments, for the same effect is obtained by heating the tubes by sepa-

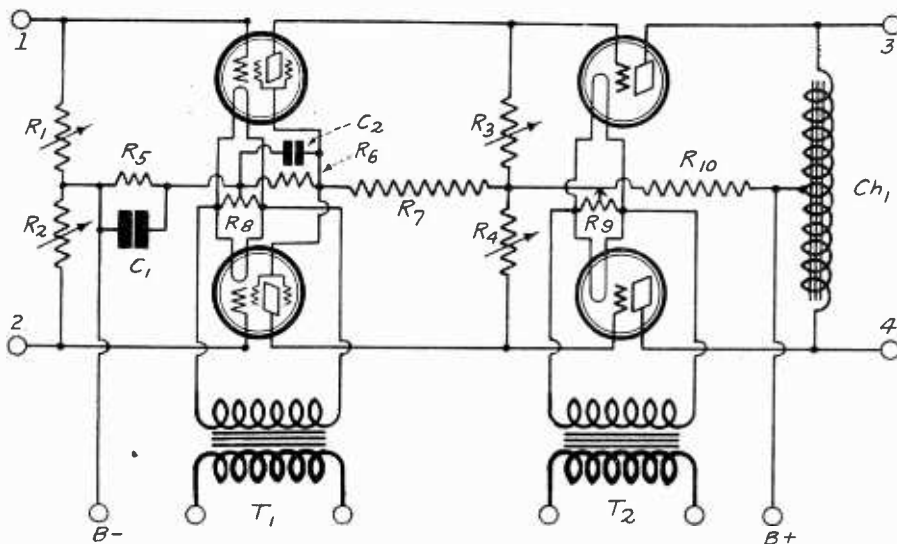

FIG. 3

CIRCUIT DIAGRAM OF A TWO-STAGE PUSH-PULL RESISTANCE COUPLED AMPLIFIER WITH SCREEN GRID TUBES IN FIRST STAGE. DIRECT COUPLING IS USED WITHOUT STOPPING CONDENSERS BETWEEN STAGES.

# Resistance Amplifier

Anderson

Editor

rate transformers, or separate windings on the same transformer.

The plate voltage is obtained from drops in resistors placed between the stages. This drop is due to the plate current and to the so-called "bleeder" current, that is, the current which flows through the resistance coupled network even when the filaments of the tubes are not heated. The Paris system is much more flexible in that tubes of different characteristics may be used in the different stages.

Although the Johnston circuit has not yet appeared in push-pull it may so be used. Also the Paris system may be used in a single sided circuit as well as in push-pull. When used in push-pull the Paris circuit, if applied to resistance coupling, has all the advantages of the original push-pull, resistance coupled circuit published by the writer, and nearly all its disadvantages as well.

But the absence of coupling condensers considerably simplifies the circuit and makes it more effective at the low frequencies. It will not be subject to the difficulty of grids going positive.

The chief difficulty of the circuit is in adjustment. All direct coupled circuits without stopping condensers are subject to the same difficulty.

### Diagram of the Circuit

The writer has been experimenting with resistance coupling along the line suggested by Mr. Paris ever since the circuit was first proposed, and it is a circuit of this type which will be presented.

The first requirement for such a circuit is a source of high voltage. In fact, it should be almost as high as the sum of all the voltages applied to the different stages. Thus if the voltage required on the last push-pull stage is 180 volts, that required on the second 150 volts, and that required on the first 50 volts, the source should have a voltage of 380 volts.

Why a somewhat lower voltage may be used will be brought out in the discussion.

When batteries are used to supply the voltage this presents quite a problem. But now that high voltage B battery eliminators are available there is no such problem.

Fig. 1 shows a diagram of a three-stage, resistance coupled push-pull circuit almost as proposed by Mr. Paris for impedance coupling. The circuit has been simplified as much as possible as an aid to exposition.

There are three pairs of tubes, each pair supposed to consist of identical tubes. There are also three potentiometers R1, R2 and

R3, used as coupling resistors. The sliders on the potentiometers are adjusted so that the resistance is accurately halved.

The input is impressed across the terminals 1 and 2 and the output is taken at 3 and 4. A mid-tapped high impedance choke coil Ch is connected across the speaker to take the plate current.

### High Voltage Impressed

The high voltage source is connected between the points B minus and B plus, which are joined by a suitable voltage divider R4.

Each pair of tubes is heated by a separate winding, the terminals of which are supposed to be connected to the circles above each pair. The center circle in each case is either a mid-tap on the filament winding or it is the mid-point on a resistor connected across the filament terminals.

The effective plate voltage on any pair of tubes is the voltage drop in that portion of the voltage divider R4 which lies between the mid-point of a filament and the mid-point on the succeeding coupling resistor. Thus the plate voltage on the first pair is the drop between A and B, that on the second pair the drop between C and D, and that on the third pair the drop between E and B plus. This is true whether the points are connected as shown in the circuit diagram or in some other order.

### Waste of Voltage

The connection of the mid-points to the voltage divider shown in Fig. 1 is wasteful of voltage, for the drops between B and C and between points D and E serve no useful purpose. On the contrary these drops are very detrimental, for they affect the grid bias voltages on the stages concerned.

And that brings the discussion to the most difficult feature of the circuit, the adjustment of the grid bias to suit the effective plate voltage used.

Systematic procedure in solving this problem requires a knowledge of the grid voltage, plate output voltage characteristics of the tubes for the values of plate voltage to be used. Such curves have been printed in preceding issues of RADIO WORLD. The first set of curves was published in the August 11th issue. Other curves were published in the September 1st and September 8th issues.

### Method of Design

The curves published by Captain Peter V. O'Rourke in the September 8th issue is of special application to the circuit under con-

sideration, for they were taken as an aid in designing the circuit.

The first pair of tubes is of the -26 AC type. The lower curve in the graph of Captain O'Rourke's article is for that tube taken with 50 volts on the plate when both tubes were heated by the transformer. That is, the curve was taken on one of tubes under actual operating conditions. The two tubes were sufficiently alike to give practically the same curve when both had equal resistance loads.

It will be observed that the region between 3 and 4 volts bias is suitable. This bias is obtained from the drop in the portion of R4 which lies between B minus and A. The total current through this section was held at 50 milliamperes. Thus a resistance of 75 ohms will give a bias of 3.75 volts. A commercial unit of this value was selected and checked to make sure of its value.

When the bias on the tube is 3.75 volts the voltage drop in the corresponding half of R2 is 30 volts, as can be seen from the curve. This would be the bias on the next tube if C were connected to B. But this bias is too high for the high mu tube, which was used in the second stage. Hence C has to be connected to some other point.

### Plate Voltage Adjustment

The effective plate voltage on the first stage is the drop in R4 between A and B, which is supposed to be 50 volts. The plate current from the two first tubes is much less than one milliampere, so that it is permissible to assume that the current between A and B is 50 milliamperes. Hence the resistance between A and B should be 1,000 ohms. A commercial resistor rated at this value was selected. It measured slightly more than the rated value, but that was all right for the actual current through it was a little less than the assumed value. It was less by the amount of plate current in the first two tubes.

The choice was a happy one, for the measured voltage was 51 volts, obtained by a vacuum tube voltmeter.

The resistor selected for the AB position had a slider tap for the connection of C. That is, C was connected to the left of B and not to the right, as shown in the drawing. Just how far this tap had to be connected to the left was determined with the aid of the upper curve in Captain O'Rourke's graph. That curve shows that the bias on the second pair of tubes should be 5 volts to give optimum results.

(Continued next week)

**FIG. 4**  
The circuit diagram of a complete receiver in which a two-stage push-pull resistance coupled amplifier is used. The first two push-pull tubes are heated by the storage battery. This circuit does not hum. Direct coupling without stopping condensers is used.

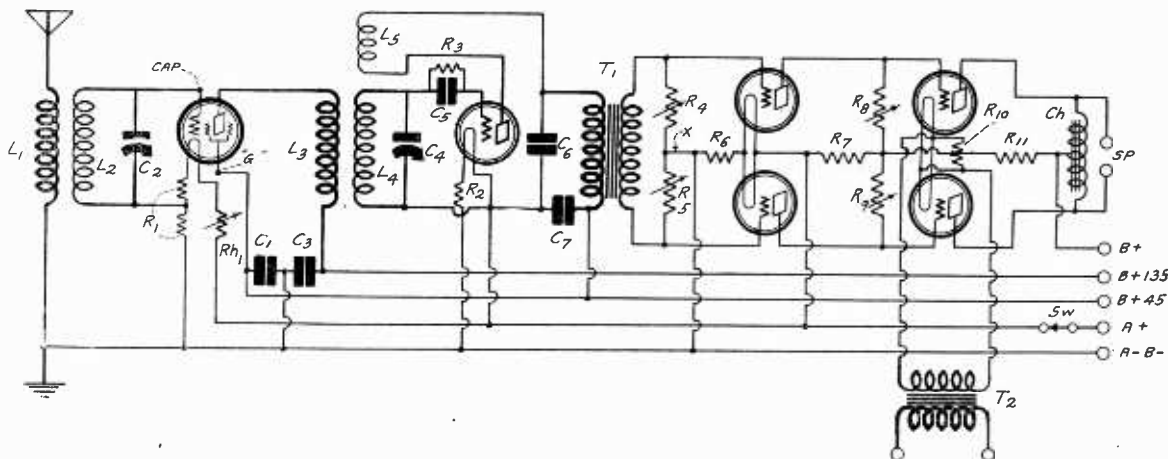

# 110 Mfd., V Voltage A

By John

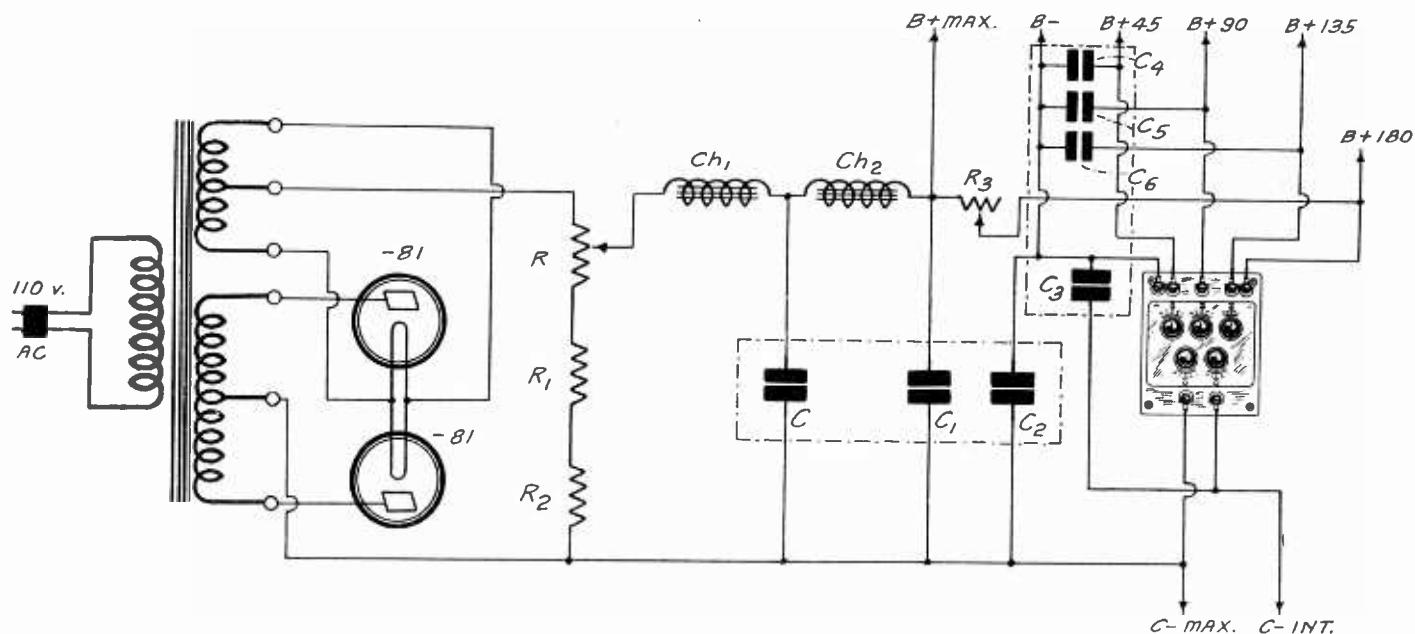

CIRCUIT NETWORK OF THE B ELIMINATOR THAT HAS 110 MFD. AND ACCURATE VOLTAGE CONTROL.

BATTERY eliminators of previous vintage were burdened with two annoying considerations—the operating life of the filter condensers and the calculation of the resistance values constituting the output voltage distributing system.

With the high cost of paper dielectric filter condensers, which once punctured are useless thereafter, it is indeed important to employ units with a DC working voltage rating sufficiently high to insure perfect operation after a momentary surge, since the replacement of "lone" condensers is an expensive proposition. The Mershon condensers solve this problem. They are self-healing in case of puncture. Also they compactly afford high capacity.

With respect to the voltage distribution system, the subject is of equal interest. The bugaboo of all B eliminator construction by the man who is not in possession of an electrical education of even rudimentary character, is the calculation of the sections constituting the voltage distributing system in a B eliminator. Expressed differently, it is the calculation of the resistances comprising the output circuit of the B eliminator and which provide the required output voltages. Haphazard calculation of these resistors invariably produced two results; insufficient or excessive plate voltages applied to the tubes in the receiver, both of which produce the same effects—distortion and instability.

### Divider Is Panacea

An analysis of B battery eliminator design ever since its advent brings to light three significant facts.

First, similar voltage distribution systems, as a matter of fact identical voltage distribution systems, are utilized in all B battery eliminators.

Second, the electrical constants of all voltage distribution systems are practically identical; that is, they do not differ by appreciable values.

Third, a set of variable resistances could be arranged to form a voltage distribution system suitable for every conventional type of B battery eliminator and which would obviate the necessity of calculating resistances. Being variable, the variable control could be adjusted until the required voltage output was obtained.

A unit of this type removes the greatest obstacle confronting the uninitiated B eliminator constructor and the person who is unfamiliar with electrical laws.

What matter the number of tubes in a receiver, the types of tubes in a receiver, the current output of the B eliminator, the voltage output of the B eliminator? All B eliminator voltage distribution systems are alike, hence one system is applicable to all.

If the power rating of the components of the system is selected for maximum current and voltage specifications, it is applicable to all B eliminators, since the resistors are variable in ohmic value.

This development is the result of three years' analysis and is the panacea for all who have been troubled by any difficulty in the voltage distribution section of the B eliminator.

The necessity for resistance calculation to obtain proper output voltages is obviated by the use of the new Electrad Tru-volt Divider.

### Two Excellent Selections

So we have two commercially obtainable products that afford just what we desire and permit the construction of a splendid B supply.

The foregoing brief outline, however, by no means exhausts the reasons for the choice of these two products. Reverting to the Mershon condenser, we find that it meets superbly the momentary voltage increase when an eliminator is turned on.

To preclude the possibility of condenser breakdown at these moments of excessive voltage, the DC working voltage of the filter condensers used in any installation is usually of such value as to approximate closely the peak AC voltage in the circuit. Not that this momentary surge is equal in value to the peak AC potential input and output of the rectifier system, but by selecting the condensers as mentioned a greater safety tolerance is obtained. The attainment of a satisfactory safety tolerance is an expensive undertaking since comparatively high rated working voltage condensers of paper dielectric are by no means inexpensive units.

The introduction of the Mershon liquid high capacity electrolytic condenser for B eliminator filter circuits simultaneously introduces economy into the filter circuit by virtue of the operating characteristics and the self-healing properties. In direct contrast to the paper dielectric condenser, a rupture of the dielectric on the Mershon is only momentary, being healed by the next cycle of current, if of normal value.

Once the paper dielectric has been punctured, the utility of that condenser ends and the price paid for the product is lost.

The electrolytic condenser, on the other hand, will withstand puncturing potentials without any harm, although at the moment of puncture the function of the condenser is the same as that of the paper dielectric unit. If the puncturing voltage is only instantaneous and at the next cycle is normal, the accompanying cycle of current of normal value heals the electrolytic condenser and the condenser is as good as new. In contrast to the paper dielectric condenser, wherein wood pulp paper or linen paper is utilized as the dielectric, the insulating medium or dielectric in the electrolytic condenser is an oxide film upon the aluminum plates. The elements constitute one of the active surfaces of the complete condenser.

### Close Rated Voltage O. K.

Because of this self-healing property, the DC working voltage rating of the condensers used need be only slightly higher than the DC voltages encountered in the circuit, without fear of permanent injury during instantaneous surges.

The fact that a momentary surge ruptures the electrolytic condenser does not signify the necessity for a higher working voltage rating. This is true for several reasons.

First, such abnormally high surges are encountered only when the eliminator is placed into service and when the receiver load is removed. Both of these moments do not interfere with the operation of the receiver.

Second, such high surges are seldom encountered during the operation of the B eliminator, since they necessitate appreciable fluctuations in line voltage.

Third, an instantaneous surge of this

# Accuracy In B Supply

F. Rider

### LIST OF PARTS

- One full-wave power transformer for two 281 tubes.
- Two 30 henry 130 mil filter chokes.
- Two four-prong sockets.
- One Mershon Q4-10 electrolytic condenser.
- One Mershon Q2-10-2-25 electrolytic condenser.
- Two Electrad 2,000-ohm type D fixed resistances with slider clip (R, R1).
- One Electrad 40,000-ohm type D fixed resistance (R2).
- One Electrad 10,000-ohm type D fixed resistance with slider (R3) clip.
- One Electrad Truvolt Divider.
- Two 281 type tubes.
- One baseboard 10 x 18 inches.
- Connecting wire.

nature, which would rupture the condenser and cause an instantaneous short across the rectifying tube with the possibility of injury, is instead limited solely to the condenser directly adjacent to the rectifying tube. Since the electrolytic condenser is self-healing, this instantaneous short does not injure the rectifying tube. If the momentarily blown condenser is located at the midpoint of a two-section filter, a momentary short across the condenser has negligible effect upon the tube because of the presence of the first filter choke.

All of the above is applicable only to DC potentials, the electrolytic condenser of the present day being for use on AC. When considering B battery eliminators, however, we are concerned solely with DC potential. Consequently, the electrolytic condenser is important to the B eliminator constructor.

All of the enumerated advantages introduced in a 1929 model B battery eliminator rated at 350 volts and 200 mils, suitable for 171,210 and the 250 tubes. Since the 250 is replacing the 210, we can classify this eliminator suitable for the two popular types of output tubes.

The same B power unit supplies B potential to all of the other tubes in the receiver.

This B power unit is novel in several respects:

First, it employs a voltage distribution system whose sections need not be calculated.

Second, it employs the electrolytic condenser with practically an indefinite life, since it is self-healing.

Third, it employs a choke feed, thereby

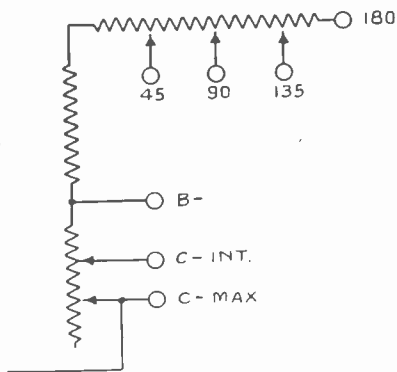
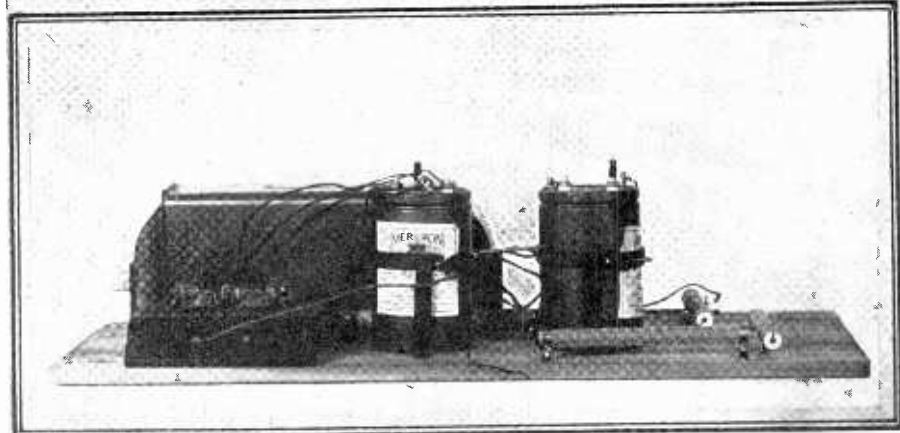
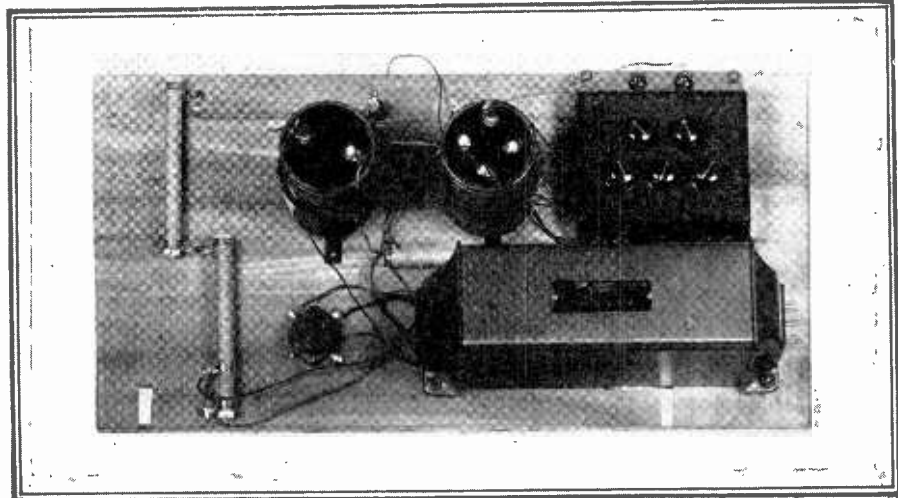

FIG. 2  
THE INTERNAL CONNECTIONS OF THE NEW TRUVOLT DIVIDER.



THE TOP AND SIDE VIEWS OF THE EXPERIMENTAL MODEL FROM WHICH THE FINAL CIRCUIT WAS DEVELOPED.

increasing the operating life of the filament type of rectifier tubes. Fourth, it employs a voltage divider system between the rectifying system and the filter system whereby the rectifying system voltage output can be varied until a value is reached where the electrolytic condensers with their 400 volt DC peak voltage rating can be used in a filter system which will supply approximately 350 or 360 volts output.

Under normal circumstances 600-volt condensers would be necessary in a filter system supplying 350 volt output. A 350-volt output for a 250 tube is quite satisfactory, since 2.65 watts undistorted output is available from a 250 tube with 350 volts applied to the plate.

Comprehension of the electrical features is facilitated by a study of the wiring diagram. The rectifying system is a con-

ventional full-wave arrangement utilizing two 281 type tubes. The voltage divider system R, R1 and R2, connected across the rectifier, allows the selection of the proper rectifier output voltage so that the electrolytic condensers C and C1 may be used with an output voltage of 350 volts at B maximum.

The resistance R3 is employed to reduce the maximum voltage to a value suitable for use with the voltage distribution system so as to provide B voltages from 22 to 180 volts. It may surprise many readers to hear that the average full wave 281 B eliminator supplies approximately 700 volts at a 60 mil drain and 500 volts at a 100 mil drain.

If this value of voltage is not being employed, it is necessary to reduce it by means of voltage-reducing resistances; (Continued on page 24)

AT RIGHT, BINDING POST ARRANGEMENT OF THE MERSHON ELECTROLYTIC CONDENSERS SHOWING HOW TO CONNECT THEM.

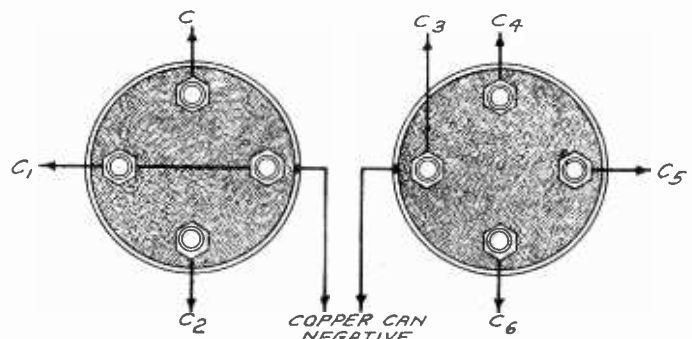

**A THOUGHT FOR THE WEEK**  
**T**HE new radio dramaturgy is seriously attracting the attention of those who formerly scoffed at broadcasting as something to do only with jazz or low-browed drivel. Those who heard a condensed version of "Arrah-na-Pogue" over the air of a recent evening know that the playlet, either comic or tragic, has vast possibilities when written tersely and pungently, and is presented with tangy atmospheric suggestion and by a cast that knows the power and appeal of the human voice when intelligently used.

# RADIO WORLD

The First and Only National Radio Weekly

Radio World's Slogan: "A radio set for every home."

TELEPHONES: BRYANT 0558, 0559  
 PUBLISHED EVERY WEDNESDAY  
 (Dated Saturday of same week)  
 FROM PUBLICATION OFFICE  
**HENNESSY RADIO PUBLICATIONS CORPORATION**  
 145 WEST 45TH STREET, NEW YORK, N. Y.  
 (Just East of Broadway)  
**ROLAND BURKE HENNESSY, President**  
**M. B. HENNESSY, Vice-President**  
**HERMAN BERNARD, Secretary**  
 Kansas City, Mo.: E. A. Samuelson, 300 Coca Cola Bldg.  
 Los Angeles: Lloyd Chappel, 611 S. Coronado St.  
 European Representatives: The International News Co.,  
 Breems Bldgs., Chancery Lane, London, Eng.  
 Paris, France: Brentano's, 8 Avenue de l'Opera.

EDITOR, Roland Burke Hennessy  
 MANAGING EDITOR, Herman Bernard  
 TECHNICAL EDITOR, J. E. Anderson  
 ART EDITOR, Anthony Sodare  
 CONTRIBUTING EDITORS:  
 James H. Carroll and Capt. Peter V. O'Rourke

**SUBSCRIPTION RATES**  
 Fifteen cents a copy. \$6.00 a year. \$3.00 for six months. \$1.50 for three months. Add \$1.00 a year extra for foreign postage; Canada, 50 cents.  
 Receipt by new subscribers of the first copy of RADIO WORLD mailed to them after sending in their order is automatic acknowledgment of their subscription order. Changes of address should be received at this office two weeks before date of publication. Always give old address; also state whether subscription is new or a renewal.

**ADVERTISING RATES**  
 General Advertising

1 Page, 7 1/4" x 11"	462 lines	\$300.00
1/2 Page, 7 1/4" x 5 1/2"	231 lines	150.00
1/2 Page, 8 1/2" D. C.	231 lines	150.00
1/4 Page, 4 1/2" D. C.	115 lines	75.00
1/4 Page, 4 1/2" S. C.	57 lines	37.50
1 Column, 2 1/4" x 11"	154 lines	100.00
1 Inch		10.00
Per Agate Line		.75

**Time Discount**

52 consecutive issues	20%
28 times consecutively or E. O. W. one year	15%
13 times consecutively or E. O. W.	12 1/2%
4 consecutive issues	10%

WEEKLY, dated each Saturday, published Wednesday.  
 Advertising forms close Tuesday, eleven days in advance of date of issue.

**CLASSIFIED ADVERTISEMENTS**  
 Ten cents per word. Minimum 10 words. Cash with order. Business Opportunities, 10 cents per word. \$1.00 minimum.

Entered as second-class matter March 23, 1923, at the Post Office at New York, N. Y., under the Act of March 3, 1879.

## Foreign Business Good

Nat Greene, vice-president of the Polymet Manufacturing Corporation, makers of electrical set essentials, reports a large and increasing demand for American made radio parts and accessories from Europe and South America.

"Radio is not the province of any one country or any one people," said Mr. Greene. "The whole world has the 'bug'. Not only are orders from Europe and Latin America increasing in quantity, but the quality of parts demanded is becoming higher all the time."

## Station Order Ousts Eight, Cuts Power

Of 162 stations cited in the General Order No. 32 of the Radio Commission to show cause why they should not be deleted for failure to serve public interest, necessity or convenience, eight have been ordered deleted, the licenses of 33 others have been extended until October 1, and six others have been allowed to continue with reduced power.

The licenses of the following have been extended, subject to the new allocation plan now in progress:

- WKBI, operated by Fred L. Schoenwolf, Chicago, Ill.
- WBMS, WBMS Broadcasting Corp., Union City, N. J.
- WWRL, W. H. Reuman, Woodside, N. Y.
- WIBS, New Jersey Broadcasting Co., Elizabeth, N. J.
- WSGH-WSDA, Brooklyn Amateur Radio Specialty Co., Brooklyn, N. Y.
- WGCP, May Radio Broadcasting, Inc., Newark, N. J.
- WFJC, W. J. Jones Broadcasting, Inc., Akron, Ohio.
- WJBK, Ernest F. Goodwin, Ypsilanti, Mich.
- WEVD, Debs Memorial Fund, Woodhaven, New York.
- WEHS, Victor Carlson, Evanston, Ill.
- WQBZ, J. H. Thompson, Weirton, W. Va.
- WIAF, Howard R. Miller, Philadelphia, Pa.
- WDZ, James L. Bush, Tuscola, Ill.
- WJAY, Cleveland Radio Broadcasting Corp., Cleveland, Ohio.
- WOV-WGL, International Broadcasting Corp., Seacaus, N. J.
- WHPP, Bronx Broadcasting Co., Englewood Cliffs, N. J.
- WRAX, Beracha Church, Inc., Philadelphia, Pa.
- WBBW, Wilson Duncan Broadcasting Co., Kansas City, Mo.
- WLOE, William S. Pote, Chelsea, Mass.
- WPCB, Concourse Radio Corp., Hoboken, N. J.
- WFGP, Wm. F. Gable Co., Altoona, Pa.
- KICK, Atlantic Automobile Co., Red Oak, Iowa.
- KDLR, Radio Electric Co., Devils Lake, N. D.
- WBES, Tom F. Little, Salisbury, Md.
- WMRJ, Peter J. Prins, Jamaica, N. Y.
- WKBN, W. P. Williamson, Jr., Youngstown, Ohio.
- WAAT, Bremer Broadcasting Corp., Jersey City, N. J.
- WHBY, St. Norberts College, West DePere, Wis.
- WCOH, Westchester Broadcasting Co., Greenville, N. Y.
- WOMT, Mikadow Theatre, Manitowac, Wis.
- WBBC, Brooklyn Broadcasting Co., Brooklyn, N. Y.
- KGDM, E. F. Peffer, Cleveland, Calif.

- POWER REDUCTION**
- WHPC, from 200 to 100 watts.
  - WLXB, Long Island City, N. Y., from 250 to 100 Watts.
  - WSBC, World Battery Co., Chicago, Ill., from 500 to 100 watts.
  - WFWF, St. Louis Truth Center, Inc., St. Louis, Mo., from 250 to 100 watts.
  - WEDC, Emil Denemark, Chicago, Ill., from 500 to 100 watts.
  - WKBQ, The Standard Cahill Co., Inc., New York, N. Y., from 500 to 250 watts.

- ORDERED TO QUIT**
- KFOA, The Principia, St. Louis, Mo.
  - WMBJ, Rev. John W. Sproul, McKeesport, Pa.
  - KWUC, La Mars, Iowa.
  - WAIZ, Appleton, Wis.
  - WNAL, Omaha, Neb.
  - WPEP, Maurice Mayer, Waukegan, Ill.
  - WTRL, Midland Park, N. J.
  - WNBA, Michael Rafferty, Forest Park, Ill.

The license of WCOT, Providence, R. I., operated by Jacob Conn, was revoked for failure to serve public interest and on the ground "that false statements and defamatory language had been broadcast over the station."

## READ RADIO WORLD EVERY WEEK!

The very thing you've been looking for may be published in RADIO WORLD the week you may omit getting a copy. Better subscribe NOW! See three generous offers in this issue. They are of limited duration—so act NOW and cash in on this generosity!

## 600 Meters Held Safer for Aviators

Aviators contemplating long distance over-water flights are urged to use radio equipment capable of transmitting on the 500 kc "distress frequency" by the Director of Naval Communications, Captain S. C. Hooper, because this frequency is watched everywhere more than any other and its use would give the aviators a better chance of being heard in an emergency.

He pointed out that high frequency transmitters are not entirely dependable on long flights because they cannot be picked up by all ship and shore stations. While short waves carry farther than the medium waves there are not so many listening in on these waves as on the 500 kc waves, and further the short waves are subject to skip-distance which makes their reception impossible over many areas in which possible quick assistance may be located.

Captain Hooper pointed out that the Byrd transatlantic plane "America" was equipped with a radio set sending on 500 kc and that the signals were heard by ship stations throughout the flight. The British flying boat of Captain Courtney also had a medium wave set, a fact which was undoubtedly the principal cause of the early rescue of the crew.

## Board Gives Inking Of Wave Order

Washington.  
 In the general reallocation plan of the Federal Radio Commission seventy-four cleared broadcasting channels were made available for "high grade reception." Of these, thirty-four will be assigned for regional service, allowing 125 full-time stations. Forty channels will be assigned to stations with a minimum power of 5,000 watts and a maximum wattage to be determined by the Commission and to be announced at the time the complete details of the new allocation plan are made public. The plan is to become effective October 1.

The new plan provides for full-time assignments for 100-watt stations equaling in number the total of all other classes of stations.

The power of the regional stations will range from 250 to 1,000 watts. Two, three or four stations per channel will be assigned in this group, with geographical spacings of from 1,000 to 1,500 miles.

The new plan provides for eight full time assignments for stations of 5,000 watts or over for each of the five zones. It also provides for 24 positions for 500 to 1,000 watt stations and 30 positions for 50 to 100 watt stations in each zone.

The frequencies reserved for Canada are: 690, 730, 840, 910, 960 and 1,030 kilocycles.

Channels reserved for simultaneous use of Canada and the United States are: 580, 600, 630, 780, 880, 890, 930, 1,010, 1,120, 1,200 and 1,210 kilocycles.

The eight exclusive channels for each zone follow. First Zone: 660, 710, 760, 860, 990, 1,060, 1,100 and 1,150 kilocycles. Second Zone: 700, 750, 820, 980, 1,020, 1,070, 1,110 and 1,170 kilocycles. Third Zone: 650, 740, 800, 850, 1,040, 1,080, 1,140 and 1,190 kilocycles. Fourth Zone: 670, 720, 770, 810, 870, 1,000, 1,090 and 1,160 kilocycles. Fifth Zone: 640, 680, 790, 830, 970, 1,050, 1,130 and 1,180 kilocycles.

The other frequencies are to be used by two or more stations in different zones simultaneously.

# Radio University

**A QUESTION and Answer Department conducted by RADIO WORLD, by its staff of experts, for University members only.**

When writing for information give your Radio University subscription number.

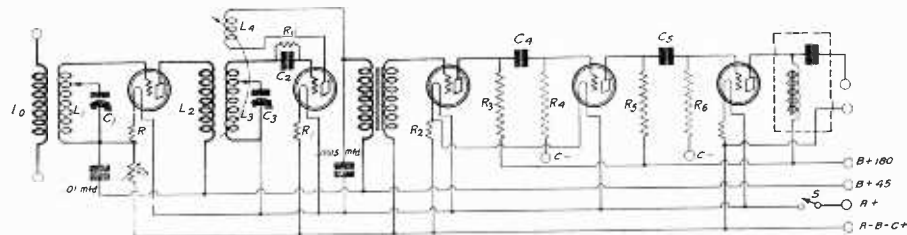

FIG. 705

**THE CIRCUIT DIAGRAM OF A RECEIVER IN WHICH THE TUNING COILS ARE TAPPED TO EXTEND THE RANGE. REQUESTED BY RAMOS FERNANDEZ.**

**IF POSSIBLE** please publish a circuit diagram having the following specifications: It should have one stage of RF, a regenerative detector, one audio transformer and the rest resistance coupling. The tuning coils should be provided with taps so that the tuning range may be extended up to 1,000 meters.

**RAMOS FERNANDEZ,**  
Fort Worth, Texas.

(1) See Fig. 705 for such a circuit.

\* \* \*

**PLEASE SHOW** how to determine the current required by a voltmeter when the resistance per ohm is known.

(2) Does the resistance per ohm remain the same for all readings of the meter?

**ALBERT HUDSON,**  
Butte, Montana.

(1) Multiply the maximum reading on the voltmeter by the resistance per volt. That gives the total resistance of the meter. Then divide any other reading by this resistance and the result is the current that flows in the meter at that reading. For example, suppose the resistance per volt of a 0-100 voltmeter is 200 ohms. Then the total resistance is 100x200 or 20,000 ohms. Then at 50 volts the current is 50/20,000 amperes, or 2½ milliamperes. At full voltage reading the current is 100-20,000, or 5 milliamperes.

\* \* \*

**I BOUGHT** a short-wave three circuit tuner supposed to cover the range 25-100 meters. The coil seems to be in perfect condition, but I can get no signals with it. Can you suggest a remedy?

**THOMAS WILLIAMS,**  
Baltimore, Md.

It is possible that there are not enough turns on the tickler to make the circuit oscillate. Increase the number of turns by 50 per cent. The single coil will not cover the entire range from 25-100 meters.

\* \* \*

**I WOULD LIKE** to build a "one spot" Super-Heterodyne but don't know which one to select. Kindly advise which one is the best.

(2)—What determines whether or not a Super-Heterodyne is "one spot?"

(3)—Is a "one spot" Super free from heterodyne squeals as are present in ordinary Supers?

**WILLIAM BARTLETT,**  
Waukegan, Ill.

(1)—Cannot advise building the impossible.

(2)—There is no "one spot" Super-Heterodyne in fact. All are "multi-spot." A Super-Heterodyne is called "one spot" when in some manner one of the two main tuning points where a given signal comes in is concealed. This concealment may be accomplished in one of two ways.

First, the dial of the oscillator may be coupled mechanically to the dial of the RF condenser so that the oscillator cannot be turned to the second main tuning point. Second, the intermediate frequency may be made so high that for most of the stations the second tuning point is off the dial. In neither case is the "two spot" tuning done away with. But the advantages of "two spot" tuning are done away with when the condensers are ganged.

(3)—The squeals are present except that when the intermediate frequency is high they are not so frequent. Hence there is only that advantage in building a Super with a high intermediate frequency.

\* \* \*

**IN JAMES MILLEN'S ARTICLE** in the September 1st issue he stated that he had difficulty holding his scanning disc at synchronous speed when he was using a universal motor and that he intended trying a synchronous motor. Would it not be impossible to achieve synchronism with the synchronous motor, if the transmitter were not operated on the same power system?

**GENARO D'ALESSANDRO,**  
W. Quincy, Mass.

(1)—It would at least be very difficult. It would be impossible if the frequencies of the two different power systems were not exactly equal and absolutely steady. Mr. Millen has used a synchronous motor with satisfactory results, utilizing speed reduction gears. But for general work, as he says, the induction motor, with a variable resistor controlling speed, is all right.

## Literature Wanted

THE names and addresses of readers of RADIO WORLD who desire literature on parts and sets from radio manufacturers, jobbers, dealers and mail order houses are published in RADIO WORLD on request of the reader. The blank below may be used, or a post card or letter will do instead.

RADIO WORLD,  
145 West 45th St., N. Y. City.

I desire to receive radio literature.

Name .....

Address .....

City or town .....

State .....

- E. B. Hanby, Coal Valley, Alabama.
- Chas. W. Yeager, 1316 So. Date Ave., Alhambra, Calif.
- D. C. Kelly, the Gateway Production Co., 5315 Tracy Ave., Kansas City, Mo.
- Keystone Tire Co., 5908 Penn Ave., Pittsburgh, Penna.
- L. E. Sutton, Monroe, North Carolina.
- Ernest C. Hampton, 25 Park Ave., Freehold, N. J.
- J. M. Clement, Mineral Bluff, Georgia.
- W. Daines, 331 4th St., Fall River, Mass.
- F. G. Bullington, 223 E. Broad St., Richmond, Va.
- H. E. Gould, Room 631, 31 St. James Ave., Boston, Mass.
- Walter Hawkins, P. R. 1, Box 50, Wakarusa, Indiana.
- Andrew W. Grabau, State Teachers College, Buffalo, N. Y.
- G. A. Thurling, 27 Beese Pl., Springfield, Mass.
- A. B. Archibal, P. O. Box 1075, St. Petersburg, Fla.
- Wones Radio, 3938 Sheridan St., Minneapolis, Minn.
- J. S. Danahy, 2516 Eleventh St., Altoona, Penna.
- David B. Hornsichter, 609 E. 135th St., New York City.
- Howard R. Bergeon, 500 E 165th St., New York City.
- Harold Beggell, 28 Stewart St., Washington, N. J.
- A. W. Moore, 522 W. Barraque St., Pine Bluff, Arkansas.
- L. L. Fontna, Arkansas Ldr. Co., Coyle, Oklahoma.
- Warren Barker, 203 Ashbrook, Venice, Ill.
- Roy A. Jensen, Lyons, Nebraska.
- N. J. Schudler, 1234 So. Alma St., Los Angeles, Calif.
- A. Kohnert, 1758 1st Ave., New York City.
- P. W. Eliason, 2 N. Maine, Logan, Utah.
- Holly G. Avery, Katonah, New York.
- P. Lettofsky, 979 Parkwood Drive, Cleveland, Ohio.
- J. E. Boylan, 704 Douglas St., Bloomington, Illinois.
- Irving Robinson, 1446 Lincoln Pl., Brooklyn, N. Y.
- Emil Herrmann, 224 E. 75th St., New York City.
- Peter S. Kilburg, 5324 Parker Ave., Detroit, Michigan.
- Alfonso Donofrio, 651 Woodland Ave., Toledo,

## Join RADIO WORLD'S University Club

And Get Free Question and Answer Service for the Coming 52 Weeks  
This Service for Yearly Subscribers Only

Have your name entered on our subscription and University lists by special number. Put this number on the outside of the forwarding envelope (not the enclosed return envelope) and also put at the head of your queries. If already a subscriber, send \$6 for renewal from close of present subscription and your name will be entered in Radio University. No other premium given with this offer.

[In sending in your queries to the University Department please paragraph them so that the reply can be written under or alongside of each query. Write on one side of sheet only. Always give your university number.]

RADIO WORLD, 145 West 45th Street, New York City.

Enclosed find \$6.00 for RADIO WORLD for one year (52 nos.) and also enter my name on the list of members of RADIO WORLD'S University Club, which gives me free information in your Radio University Department for 52 ensuing weeks, and send me my number indicating membership.

Name .....

Street .....

City and State .....

# Readers Get Offer of Free Blueprint

**Calibrated  
Voltage**

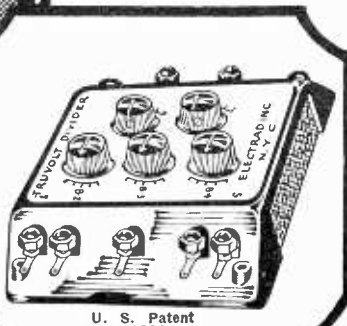

U. S. Patent  
1676869

**TRUVOLT  
DIVIDER**

**E**LECTRAD'S new one-piece resistance unit separates filtered voltage into the exact value needed for each output terminal. Saves all mathematical calculations, wiring difficulties and use of voltage regulator tubes.

**List Price, \$12.50**

Electrad Specializes in a Full Line of Resistance Controls for all Radio Purposes, Including Television.

*Write for Free Circuit Data and Description of TRUVOLT Divider.*

**175 VARICK ST.  
Dept. 31-A  
New York**

**ELECTRAD**

EXCELLENT unit for phonograph attachment, to play records. Connects to speaker terminals, nozzle to phonograph, \$4.20. P. Cohen, 236 Varet St., Bklyn., N. Y.

**SEND FOR NEW RADIO BOOK—IT'S FREE**

New hook-ups. This book shows how to make short wave receivers and short wave adapters. How to use the new screen grid tube in DC and AC circuits. How to build power amplifiers. ABC eliminators. Up-to-the-minute information on all new radio developments. It's free. Send for copy today.

**KARAS ELECTRIC CO.**  
4039J2 N. Rockwell Street Chicago

Name .....

Street and Number .....

City and State .....

4039J2

(Concluded from page 21)  
but these voltage-reducing resistances are located in the output circuit and it is necessary to employ filter condensers which are capable of operating at the maximum voltage. By limiting the maximum voltage to 350 volts, which is very satisfactory for 250 tube, we obtain sufficient voltage and are still able to effect economy by employing the electrolytic condensers.

**What X Equals**

The main voltage divider (R, R1 and

THE AMRAD MERSHON CONDENSER

*Vastly Greater Capacity at  
Lower Price than Paper  
Condensers is Obtainable  
in the self-healing*

**MERSHON  
CONDENSER**



The tremendous capacity, the compactness and the self-healing properties of the Mershon Condenser make it the choice in experts' design of B supplies.

Specified by John F. Rider in his featured article on pages 20 and 21 of this issue. ONE of the most sensational devices in the history of radio engineering—the Mershon Condenser has revolutionized the building of electrical sets. B eliminators, power packs, and has a score of other important uses in radio. Unaffected by moisture. Self-healing in case of puncture!

We have issued a new book describing the Mershon Condenser, showing hook-ups and diagrams, and giving information about its many uses in the radio field. We will be glad to send you a copy FREE if you will address Department RW, or use the coupon below for quick action.

**THE AMRAD CORPORATION**  
Medford Hillside, Mass.  
J. E. HAHN, President  
POWEL CROSLLEY, JR.  
Chairman of the Board

THE AMRAD CORPORATION  
Dept. RW, Medford Hillside, Mass.  
Gentlemen: Please send me a copy of your new booklet describing the Mershon Condenser.

Name .....

Address .....

City .....

State .....

R2) consist of three resistances as shown. The first two R and R1 are of 2,000 ohms each and rated at 75 watts, capable of passing 194 mils. R2 is a 40,000 ohm resistance rated at 75 watts capable of passing 43 mils. The reason for selecting these values of resistance is as follows:

Assuming a transformer voltage of 600, the peak voltage output of the rectifying Esystem is approximately 840 volts. The total resistance network R, R1 and R2 of 44,000 ohms results in a leakage current of approximately 19.1 mils. However, one section of this network must carry the total plate current consumed in the B eliminator output or the total drain of the filter system and the voltage distribution system. The two 2,000-ohm resistances capable of passing 194 mils are supplied for the purpose, the tap designated as X being at some position on one of these two resistances.

The current flow equal to the current drain system and the voltage distribution system flows through the portion of R or R1 located between the tap X and a positive lead from the rectifier system. The leakage current due to the placement of this network across the rectifying system flows through the remaining portion of R, R1 and R2. The tap X is a sliding clip.

R3 is a 10,000-ohm resistance rated at 75 watts, made variable by means of a sliding clip, and is used to reduce the maximum voltage across the distribution system unit to 220 volts, after which the voltage distribution system unit is used in a conventional manner. (In the event that the rectifier system is of such type that the maximum output voltage is 220 volts, the voltage divider network R, R1 and R2 and the resistance R3 are omitted).

**110 Mfd., All Told**

Electrolytic condensers are utilized throughout and because of their high capacity result in very satisfactory operation of the filter system and in minimization of the hum. C, C1 and C2 are sections of an electrolytic condenser with a maximum capacity of 70 mfd., C being a 10 mfd. section, C1 being a parallel connection of the two 225 mfd. sections, or 50 mfd. in all, and C2 is the other 10 mfd. section. The designation Q2-10-2-25 signifies two 10 mfd. sections and two 25 mfd. sections. C3, 4, 5 and 6 are 10 mfd. sections of the Q4-10 condenser.

The copper can of the electrolytic condenser is always negative.

The four terminals on the Q2-10-2-25 condenser are shown in the accompanying drawing. The terminals diametrically opposite and closest to each other are the 25 mfd. sections. The remaining two are the 10 mfd. sections. On the Q4-10, all terminals are 10 mfd. sections.

[A blueprint of the new B supply, utilizing 110 mfd. capacity Mershon condensers and a Truvolt Divider, will be sent without charge, if you address your request to John F. Rider, care RADIO WORLD, 145 West 45th Street, New York City.

**720 SCREEN GRID SIX**  
Laboratory Assembled and Tested  
Mounted in Shielding Cabinet **\$81.80**  
*Write for prices on other  
Custom Built Sets*  
**MABRY RADIO SHOP**  
1912 HAZEL AVENUE  
Beaumont, Texas



# Universal AC and DC Short-Wave Adapter Plugs! Voltage Regulator!

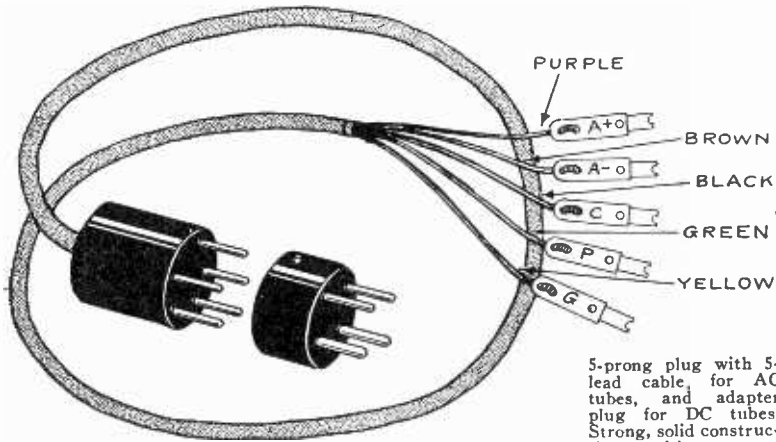

5-prong plug with 5-lead cable, for AC tubes, and adapter plug for DC tubes. Strong, solid construction, positive contact.

Handiest thing in the world for any short-wave adapter. Put detector tube of your present set in socket of any short-wave adapter you build, put plug in detector socket of your broadcast receiver. Cable, 34". Leads identified both by color scheme and tags. May be used as 5-lead battery cable plug with UY socket. 5-prong plug with 5-lead cable (Cat. No. 21AC) .....\$1.50 4-prong extra plug only, for DC short-wave adapter (Cat. No. 21DC) .....\$0.50 Cat. No. 21AC and 21DC ordered together .....\$1.75 Cat. No. 21AC and 21DC with 99 adapter .....\$2.25

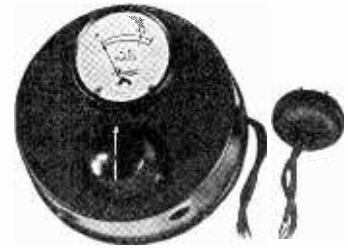

Line voltage regulator for AC sets has an AC meter showing line voltage, and a power adjustable resistance so that the line voltage may be reduced until it reads 110 volts. Wall plug and socket for connection to AC cord from the set also built-in (Cat. No. 218) .....\$5.00

## Accurate Meters for Exacting Radio Uses! Speaker Switch!



Cat. No. 390, reading 0-100 milliamperes. Price ..\$1.65



Cat. No. 326, reading 0-6 volts DC, price \$1.65

Two of the most popular meters are Cat. No. 390, reading 0-100 milliamperes, and Cat. No. 326, reading 0-6 volts DC. Both are panel mount types (2 5/64" hole). See illustrations above. No. 390 is recommended for sets having six tubes or more, particularly if a -71, -10 or -50 tube is used as the output. May be kept permanently in circuit. For DC measurements 0-100 milliamperes. Cat. No. 390 .....\$1.65 The 0-6 panel voltmeter may be kept permanently in circuit (Cat. No. 326) .....\$1.65

### PANEL AC VOLTMETER

Cat. No. 351 For reading 0-15 volts AC .....\$2.25

### PANEL MILLIAMMETERS

Cat. No. 311 For reading 0-10 milliamperes DC .....\$1.95  
 Cat. No. 325 For reading 0-25 milliamperes DC .....\$1.85  
 Cat. No. 350 For reading 0-50 milliamperes DC .....\$1.65  
 Cat. No. 399 For reading 0-300 milliamperes DC .....\$1.65

### PANEL AMMETER

Cat. No. 338 For reading amperage, 0-10 amperes DC .....\$1.65

### 6-VOLT A BATTERY CHARGE TESTER

Cat. No. 23 For showing when 6-volt A battery needs charging and when to stop charging; shows condition of battery at all times .....\$1.85

### VOLTAMMETER

Cat. No. 35 For testing amperage of dry cell A batteries and voltage of B batteries (not B eliminators); double reading, 0-50 volts, 0-40 amperes DC .....\$2.00

### HIGH RESISTANCE VOLTMETERS

A 0-300 DC voltmeter with a very high resistance. Specially made that way so it will test the output voltages, from maximum to any intermediate voltage, of any B eliminator or grid biasing resistor. Cat. No. 346 .....\$4.50

[Note: 0-500 volts, instead of 0-300 volts, is No. 347. Tests ALL power packs—Price \$5.50.]

### PANEL VOLTMETERS

Cat. No. 335 For reading DC voltages, 0-8 volts .....\$1.65  
 Cat. No. 310 For reading DC voltages, 0-10 volts .....\$1.65  
 Cat. No. 337 For reading DC voltages, 0-50 volts .....1.65  
 Cat. No. 339 For reading DC voltages, 0-100 volts .....\$1.75  
 Cat. No. 40 For testing A and B batteries, dry or storage, but not for B eliminators; double reading, 0-8 volts and 0-100 volts DC scale.....\$2.25  
 Cat. No. 42 For testing B batteries, dry or storage, but not for B eliminators; 0-150 volts DC scale.....\$2.00  
 Cat. No. 348 For testing AC current supply line, portable, 0-150 volts.....\$4.50



In home or store you often want to operate two speakers together, or each separately, and this speaker switch, the Speakerelay, does the trick! Connect the cord to the set and the speakers to the jacks in the switch. Turn knob at No. 1 at left to operate one speaker alone, to No. 2 to operate both speakers together, and to No. 1 at right to operate the other speaker alone. Enclosed in moulded Bakelite case. (Cat. No. 121).....\$2.00

## Strong, Rugged Loud Unit

Powerful unit, excellent for any cone or similar type of speaker. Stands up to 150 volts unfiltered. Very loud. Adjustable armature. Well packed. Won't get damaged in shipment. Supplied with apex, chuck and nut. Unit easily mounted. **\$3.75**

Build yourself a very fine large cone speaker and get the fullest enjoyment of the quality your receiver offers. Nothing but praise has been heaped on these 36" and 24" speakers. Also, their appearance is so entrancing that they fit nicely into the surroundings of the finest living rooms and parlors. Expert radio and acoustical engineers indorse them. Nobody need be without a really fine speaker of 36" or 24" diameter, now that all have a choice of these two sizes at the same price. Remember, a five-day money-back guaranty attaches to each of these speaker kits!

Take your choice of a 24" or 36" diameter cone speaker kit, with Unit No. 1098 (see description at left). Either size at same price. Tri-foot pedestal FREE with each kit order. Front sheet of designed Phonotex, rear sheet of plain Phonotex. Radio cement furnished with each kit. Also mounting bracket, apex, chuck and nut, with instruction sheet. Fine tone quality reproduced at large volume. Ornamental and efficient cone easily built by anybody. Novices find not the slightest difficulty. As the unit is adjustable you can adjust the impedance until best results are obtained. These speakers are used as demonstrators in stores in New York City at full volume without rattling. Low notes are reproduced particularly well, because of the large radiating surface. Apex is at center for highest efficiency. (Cat. No. 36 for 36" or Cat. No. 24 for 24").....\$6.00

Kit is complete, including unit, apex, bracket, chuck, nut, paper, pedestal, cement and instruction sheet.



If bothered by interference between stations or living near a station that comes in all over the dial and prevents you from getting other stations, use a wave trap and trap out the offender at will. Turn of the knob covers entire broadcast band. Trap is encased in moulded Bakelite .....\$1.50 (Cat. No. 22WT)....



Guaranty Radio Goods Co.  
 141 W. 45th Street, N. Y. City

Please mail at once C.O.D. on a five-day money-back absolute guaranty, your catalogue numbers as follows, for which I will pay the advertised prices, plus a few cents extra for postage:

Cat. No. .... Cat. No. .... Cat. No. ....  
 Name .....  
 Address .....  
 City..... State.....

SEND NO MONEY!

**SM** No. 720  
Screen Grid  
SIX KITS

**LIST PRICE \$72.55**

Custom Set Builders!  
Cash in on this Fine Opportunity to Build an Outstanding Performing Set!  
No. 700 Shielding Cabinet, \$9.25 extra, list price.

**THE OFFICIAL PARTS**

Only the official kit of tested parts, in factory-sealed cartons, is sold by us, all parts exactly as specified by McMurdo Silver.

These parts consist of:

Designation	Quantity	Nature of Parts	List Price
B	One	S-M 701 Universal Pierced chassis	3.00
E	One	S-M 809 dual control electrochem	2.75
D1	One	S-M 806L (left) vernier drum dial	2.50
D2	One	S-M 806R (right) vernier drum dial	2.50
C1	One	S-M 320R .00035 mfd. Universal condenser	4.00
C2-C3-C4	One	S-M 323 .00035 mfd. 3-gang condenser	13.50
C5	One	S-M 342B .000075 mfd. midget condenser	1.75
SH1-SH2	Three	S-M 638 copper stage shields @ \$1.50	4.50
SH3	One	S-M 140 antenna coil	3.00
L1	Three	S-M 132A plug-in RF transformers @ \$1.25	3.75
L2-L3-L4	Three	S-M 512 5-prong tube sockets @ \$0.60	1.80
S1-S2-S3	Five	S-M 511 tube sockets @ \$0.50	2.50
S4-S5-S6			
S7-S8	One	S-M 255 first stage A. F. transformer	6.00
T1	One	S-M 256 second stage A. F. transformer	6.00
T2	One	S-M 708 10-lead, 5-foot connection cable	1.75
W	One	S-M 818 hook-up wire (25 ft. to carton)	.50
R1	One	Yaxley 53000, 3,000 ohm midget potentiometer	1.25
SW	One	Yaxley 500 switch attachment	.40
J1-J2	One	Yaxley 420 insulated tipjacks @ \$0.125	.25
R2-R3-R4	Three	Carter RU10, 10 ohm resistors @ \$0.25	.75
R6	One	Carter A6, 6 ohm sub-base rheostat	.50
R5	One	Carter H1/2, 1/2 ohm resistor	.25
C6	One	Potter 104, 1 mfd. bypass condenser	1.00
C7-C8-C9	Six	Sprague 1/4 mfd. midget condensers @ \$0.75	4.50
C10-C11-C12	One	Polymet .00015 mfd. grid condenser with clips	.50
C13	One	Polymet .002 mfd. bypass condenser	.40
C14	One	Polymet 2 megohm grid leak	.50
R7	One	Durham .15 megohm resistor with leads	.50
R8	One	Naald 481XS cushioned tube socket	.65
S9	Three	Moulded binding posts consisting of 8/32 screw, nut, and moulded top @ \$0.10	.30
BP1-BP2	One	Set hardware as listed below	1.00
BP3			

\$72.55

**HARDWARE SET CONSISTS OF:**

One 3/4"x1/4" hollow condenser studs; eight 1 1/2"x1/4" hollow coil studs; eight 1 1/2"x6/32 R. H. machine screws; six 1"x6/32 R. H. machine screws; twenty-nine 5/8"x6/32 R. H. machine screws; thirty-seven 6/32 nuts; forty-six Shakeproof lock washers; four 1/2"x10 R. H. wood screws; three lengths of spagetti; four lengths bus-bar; two sets binding post insulating washers; three sets instrument insulating washers; two tipjack insulating washers; one metal washer; eighteen long soldering lugs; three grid clips.

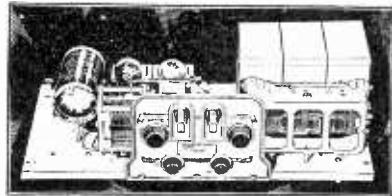

The beautiful chassis of the newest kit-set sensation the S M Shield Grid Six.

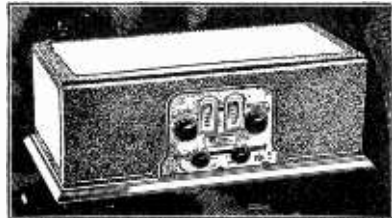

The set as it looks in a No. 700 shielding cabinet. This cabinet alone lists at \$9.25.

**UNUSUAL OFFER!**

(Applies to this kit only!)

**W**e extend not only the regular business courtesy to custom set builders, but also make the unusual offer of FREE technical information and advice on the SM-720 Screen Grid Six. Any question concerning this circuit will be promptly answered. Write, telegraph, or visit us.

When you buy from us you have expert consulting engineers at your command!

**SPECIAL!**

Full-sized pictorial blueprint of the wiring, large schematic diagram and 8-page detailed building instruction booklet.

**\$1.00**

**GUARANTY RADIO GOODS COMPANY**  
145 WEST 45TH STREET  
NEW YORK CITY  
[A Few Doors East of Broadway]

**Take Your Choice of 5 Other Publications**  
For NEW RADIO WORLD Subscribers Ordering NOW

Radio World has made arrangements

—To offer a year's subscription for any one of the following publications with one year's subscription for RADIO WORLD—

RADIO NEWS or SCIENCE and INVENTION or BOYS' LIFE or RADIO DEALER or RADIO (San Francisco).

This is the way to get two publications

- for the price of one:
- Send \$6.00 today for RADIO WORLD
- for one year (regular price for 52 numbers)
- and select any one of the other
- six publications for twelve months.
- Add \$1.00 a year extra for
- Canadian or Foreign Postage
- Present RADIO WORLD subscribers
- can take advantage of this offer by
- extending subscriptions one year
- if they send renewals NOW?

**Radio World's Special Two-for-Price-of-One Subscription Blank**

RADIO WORLD, 145 West 45th Street, New York City.

Enclosed find \$6.00 for which send me RADIO WORLD for twelve months (52 numbers), beginning ..... and also without additional cost, Radio News, or Science and Invention, or Radio Dealer, or Radio (San Francisco), or Boys' Life (or \$10.00 for a two-year subscription to one address), thereby getting RADIO WORLD and the other selected magazine, BOTH for two years. No other premium with this offer.

Indicate if renewal. Name .....

Offer Good Until Street Address .....

November 15, 1928 City and State .....

**NO OTHER PREMIUM OF ANY KIND WITH THIS OFFER**

Manufacturers of highest quality condensers and resistors that are—**Built to Endure!**

**AEROVOX**  
"Built Better"  
12 WASHINGTON ST., BROOKLYN, N.Y.

Write for the Research Worker, a free monthly publication.

**ARMOR**  
Complete Line of Quality **RADIO TUBES**  
Manufactured and Guaranteed by  
**Armstrong Electric & Mfg. Co., Inc.**  
187-193 Sylvan Avenue Newark, N. J.

**Socket Wrench**  
**FREE!**

Push out the control lever with knob (as at left) and put wrench on nut. Push down on handle only (at right), then turn nut left or right.

One of the handiest tools for a custom set builder, service man or home constructor is a BERNARD socket wrench. It consists of a 6 1/2" long metal tubing in which is a plunger, controlled by a knob. The plunger has a gripping terminal (called a socket, hence the name "socket wrench") that may be expanded or contracted to fit 6/32, 8/32 and 10/32 nuts, the most popular sized nuts in radio. Use the knob to push out the plunger, press down on the handle to grip the nut, then turn the nut to left for removal or to right for fastening down. Total length, distended, including stained wooden handle, 10". Gets nicely into tight places. Send \$1 for 8 weeks' mail subscription for RADIO WORLD and get this wrench FREE. No other premium with this offer. Present subscribers may extend subs.

**RADIO WORLD**  
145 WEST 45TH ST., N. Y. CITY  
A few doors east of Broadway

# POLO

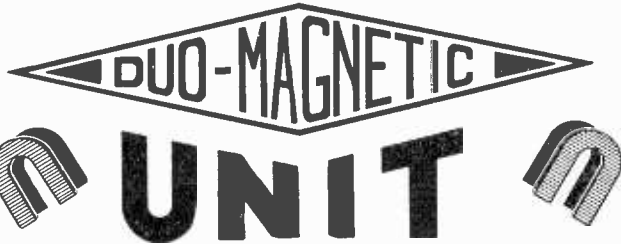

TWIN MAGNETS  
DOUBLE SENSITIVITY

## New!

The **FIRST** Twin Magnet Unit!

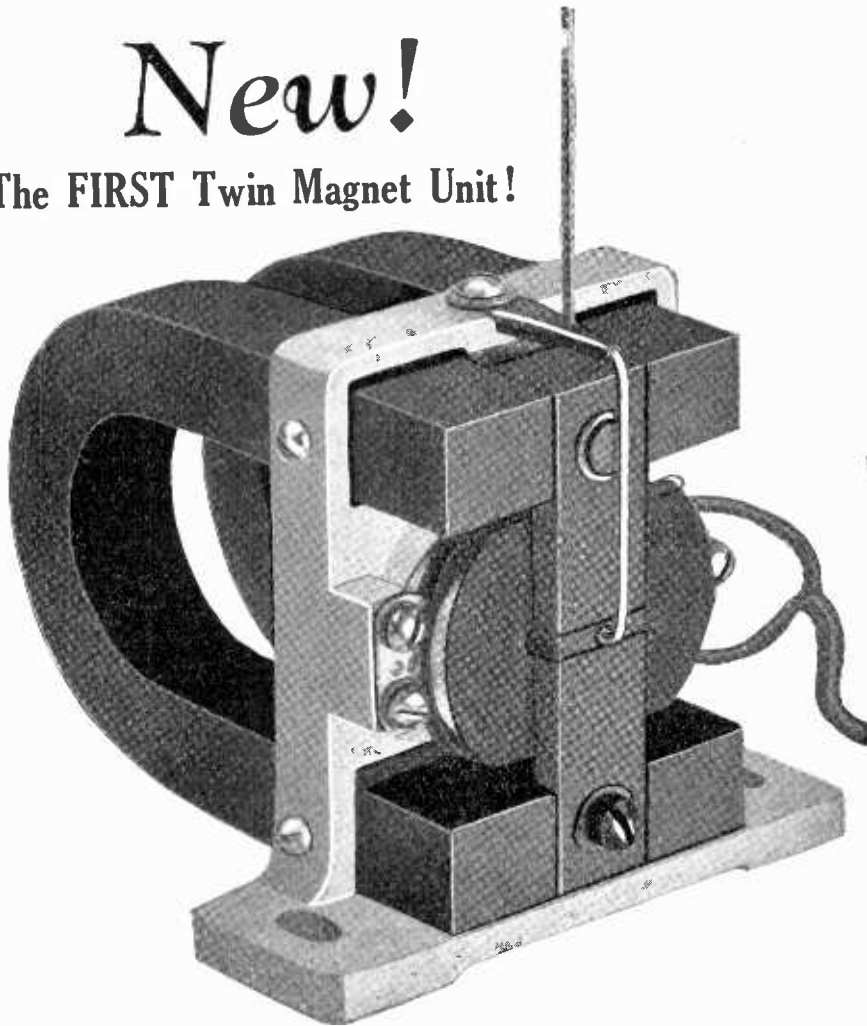

*Polo Duo-Magnetic Unit, shown actual size. Weight three full pounds. Supplied complete with ten-foot cord, apex, chuck, nut and moulded metal mounting bracket (Senior model) ..... \$10.00*

### No Filtering at 180 Volts!

**T**HE magnet coil of the unit consists of two separate windings, connected in parallel, so that the current divides between them. This enables you to put **TWICE AS MUCH** current through the coil without danger of harming it! Use 180 volts on a —71A or —10 tube, with proper negative grid bias, and you do not need an output filter, the usual list price of which is around \$10.00. The coil of the unit safely carries 25 milliamperes!

### Enormous Volume, No Rattling!

**T**HE volume obtainable from a set depends to a large extent on the efficiency of the unit. The Polo Duo-Magnetic Unit is incredibly loud—enormously loud—yet without rattling! The **SENSITIVITY IS DOUBLED** by the use of two magnets—the first time two have been used in a commercial unit. The magnets are genuine, efficient, costly chrome steel, and there are no holes in them. Holes weaken a magnet and shorten its life.

## ASTOUNDING

*Performance—And Why!*

**T**HE new and startling Polo Duo-Magnetic Unit is of the balanced armature type, needing no adjustment and no servicing. It is exceptionally efficient, long-lived and mechanically rugged. Here is a summary of its superiority:

- (1) Twin magnets double sensitivity.
- (2) Magnets are of chrome steel.
- (3) Magnet coil consists of two windings in parallel, doubling the flux and the current handling capacity.
- (4) Volume is extraordinary, and without rattling, due to twin-magnets, great flux density, short air gaps, balanced silicon steel armature and single-piece coupling rod and pin. The pin **WON'T BREAK OFF!**
- (5) Die cast aluminum frame fits assembly to 1/1000 of an inch, enhancing rigidity.
- (6) Large, solid machined pole pieces.



Moulded bracket **FREE** with each unit order; also cord, apex, chuck and nut.

Every unit undergoes seventeen careful tests and is guaranteed against all mechanical or electrical imperfections. This unit needs no after-servicing, but will last indefinitely. It works superbly any cone, cloth, Balsa or skin speaker and is one of the most remarkable units ever produced. Make Polo your choice and you'll rejoice!

**POLO ENGINEERING LABORATORIES,**  
57 Dey St. (Suite 6), corner Greenwich St.,  
New York, N. Y.

Enclosed please find ten dollars for which send me one Polo Duo-Magnetic Unit, with ten-foot cord, moulded metal bracket, apex, chuck and nut. **YOU ARE TO PAY SHIPPING CHARGES.** If after a 10-day trial I return the unit **YOU WILL QUICKLY REFUND THE TEN DOLLARS.**

NAME .....

ADDRESS .....

CITY .....STATE.....

Orders Filled in Sequence of Their Receipt

## POLO ENGINEERING LABORATORIES

57 Dey Street

(Suite 6), Corner Greenwich Street  
Tel. CORTland 5112

New York, N. Y.

# HAMMARLUND Has Something New to Show You!

At  
Section  
DD9

A New Knob-Control Drum Dial  
A New Multiple Condenser  
A New Short-Wave Condenser  
A New Short-Wave Plug-in Coil  
A New Shield-Grid Coil  
A New "Hi-Q" Receiver  
as well as the standard Hammarlund Products with NEW improvements.  
You're welcome at the Hammarlund Booth No. DD9, at the Radio World's Fair.

For Better Radio  
**Hammarlund**  
PRECISION  
PRODUCTS



**VICTOREEN  
Super Coils**  
Geo. W. Walker Co.  
2825 Chester Avenue  
Dept. B Cleveland, O.

## BIG OFFER! Radio World for 50c Four Weeks . . . Blueprint FREE!

of 4-Tube Screen Grid Diamond of the Air

At 15c per copy RADIO WORLD costs you 60c for four weeks. But if you send 50c NOW you get the first and only national radio weekly for four consecutive weeks and a blueprint FREE!  
This blueprint is life-sized and shows in easy picture diagram form how to mount parts and wire this super-sensitive receiver. One screen grid tube is used as radio frequency amplifier. The rest of tubes are two—01A and one 112A.  
This circuit gives you distance, tone quality, ease of performance. No shielding, no neutralizing required!

## ACT NOW!

This offer holds good only until November 30th and coupon below MUST be used as order blank.

Radio World, 145 West 45th Street, New York City

Enclosed please find 50 cents (stamps, coin, check or money-order) for which please enter my name on your mail subscription list for the next four issues of RADIO WORLD, and send me FREE at once a blueprint of the Four-Tube Screen Grid Diamond of the Air (front panel and subpanel wiring, schematic diagram and parts list.

Name .....  
Address .....  
City ..... State .....

Renewal.  
If you are a mail subscriber for RADIO WORLD you may extend your subscription four weeks. Put a cross in the square in front of the word "renewal," to show you are a subscriber already.

Bakelite Front and Aluminum Subpanel  
for the  
4-Tube Screen Grid  
**DIAMOND OF THE AIR - - \$5.00**

Five-Day Money-Back Guaranty

View of the Completed Receiver, using Drilled Front Panel and Aluminum Subpanel  
Finest eye appeal results from construction of the 4-tube Screen Grid Diamond of the Air when you use the official panels. The front panel is bakelite, already drilled. The subpanel is aluminum, with sockets built-in, and is self-bracketing. Likewise it has holes drilled in it to introduce the wiring, so nearly all of it is concealed underneath set. Make your set look like a factory job.

Front panel alone, bakelite, drilled.....\$2.35  
Aluminum subpanel alone, drilled, with sockets built-in..... 3.00  
Screws, nuts and insulating washers supplied with each subpanel.

**GUARANTY RADIO GOODS CO.**  
145 WEST 45TH STREET NEW YORK, N. Y.  
[A few doors east of Broadway]

# Quick Action Classified Ads Radio World's Speedy Medium for Enterprise and Sales

10 cents a word — 10 words minimum — Cash with Order

**LICENSED** Radio Doctors earn \$75.00-\$100.00 per week. Big demand; investigate at once. Free Booklet. Radio Doctors, Inc. Dept. W, Salem, Massachusetts. 9-15-28

**RECENT** issues of Radio World, 15 cents each. Any number published in 1928 available for a short while. Six issues 75 cents, 10 issues \$1.00. Send stamps, coin or money order NOW, before the issues are sold. RADIO WORLD, 145 West 45th Street, New York City.

**FREE BLUEPRINTS! GET YOUR SHARE!** National Short Wave Circuit blueprint, exact circuit used by James Millen for tuning in television, voice, code, music, programs. National Screen Grid Five (broadcast receiver circuit) blueprint FREE also. John F. Rider's B Eliminator blueprint free. Send separate request for each of the above free blueprints you desire. Custom Set Builders Supply Co., 57 Dey Street, N. Y. City.

**NEW LINEN DIAPHRAGM** speaker, superior tone quality, no details as yet published in radio press, but to alert inquirers the whole absorbing story will be enfolded. Uses new super-sensitive unit, beautiful splice-jointed frame, 18x24", with decorative moulding; absolutely a wonderful speaker. Put together in ten minutes. Rich-looking job. Write for details. Guaranty Radio Goods Co., 145 West 45th Street, New York City.

**BLUEPRINTS** of National Screen Grid Five, 4-tube Screen Grid Diamond and Karas 3-tube Short Wave Set—three blueprints—one dollar. Guaranty Radio Goods Co., 145 W. 45th St., N. Y. C.

**USED MOTORCYCLES.** Low terms. Also Parts. Accessories. Catalog Free. Western Motorcycle Co. 947 East 15th St., Kansas City, Mo. 12-5-28

**FOR SALE:** Sentinel Dry A-B-C power unit with tubes, \$44.50. 8 foot orthophonic horn size 24x18x15 inches, with Temple unit \$8.00. Fritts super cabinet, panel size 7"x24" \$12.00. Multi-valve receiver \$5.00. Aerial kit \$98. SM 222 output trans. \$3.00. Utah upright type piano speaker \$4.00. Everything guaranteed new. Charles Frick, 311 N. Cherry St., Van Wert, Ohio.

**QUICK SERVICE.** Order radio goods now, shipments made day following receipt. All merchandise pre-tested. Set of Screen Grid Coils for Bernard's Economy Three, consisting of antenna coil Model 2A and High Impedance Tuner, Model 5 HT, \$4.75. One screen grid tube, one high mu tube, one -12A tube, total for three tubes, \$7.00. Blueprint for Bernard's Economy Three, \$1.00. Front panel and subpanel for 4-tube Screen Grid Diamond of the Air, \$5.00. All merchandise guaranteed on five-day money-back basis. Send remittance and I pay carrying and shipping charges. Philip Cohen, 236 Varet Street, Brooklyn, N. Y.

# All in a Jiffy!

Tube Any Good?  
Set Getting Proper Voltages?  
Any Shorts or Open Circuits?  
Universal Tester Answers 12 Questions in a Jiffy!

You are lost without meters when you shoot trouble and seek remedies. The Universal Tester is your reliable diagnostician for both AC and DC.

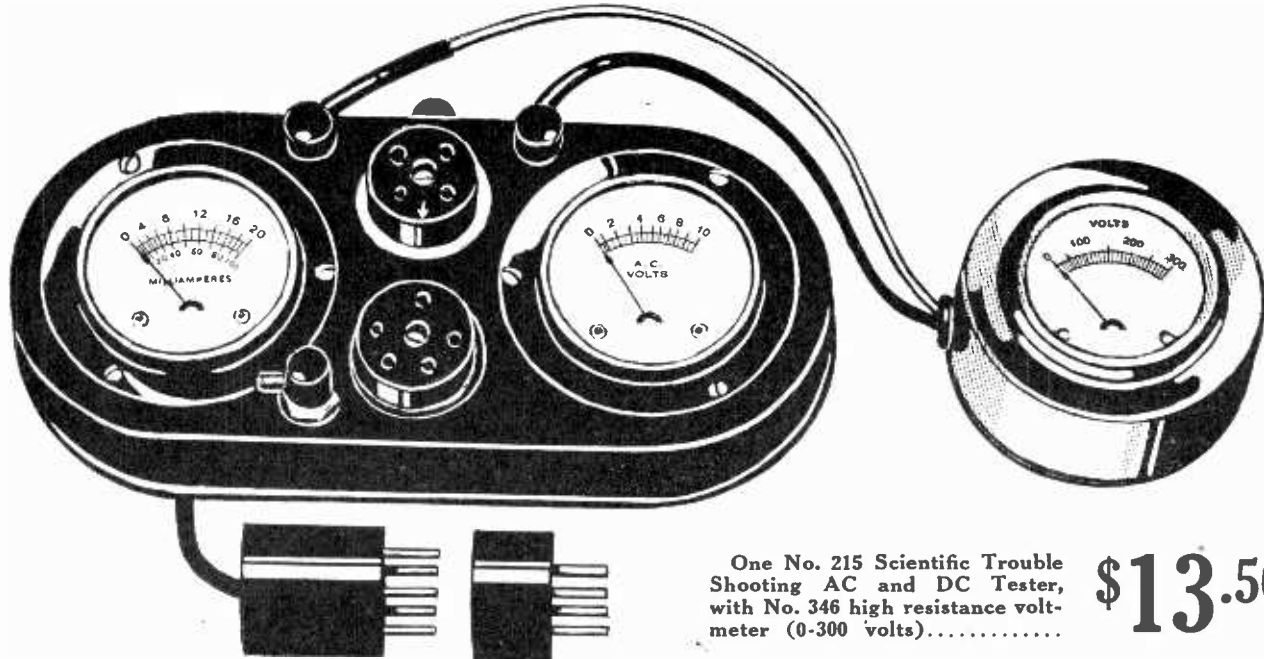

One No. 215 Scientific Trouble Shooting AC and DC Tester, with No. 346 high resistance voltmeter (0-300 volts)..... **\$13.50**

The Scientific Trouble Shooting AC and DC Tester (at left) and high resistance meter (at right) Make Twelve Vital Tests in 4½ Minutes. The instruments are exactly TWICE the size pictured. They are handy and handsome.

## Amplly Accurate, Even for Service Men!

SERVICE men, going out on calls, must have a reliable test set. The Universal Tester and separate Voltmeter are reliable and versatile. The readings are accurate to 5% plus or minus, which is ample. Twice as great accuracy as this costs four to five times as much money, and isn't really necessary, except for engineering work in laboratories.

The Universal Tester and Separate Voltmeter can be used to make ALL the following twelve tests in 4½ minutes:

- (1) to measure the filament voltage, up to 10 volts, of AC and DC tubes.
- (2) to measure the plate current of any one tube, including any power tube, from less than 1 milliamperes up to 100 milliamperes.
- (3) to measure the total plate current of a receiver or amplifier, up to 100 milliamperes. (Hardly any set draws more.)
- (4) to measure the common A and B of set and connect to P of tester socket and to P prong under adapter plug.
- (5) to measure the B voltage applied to the plate of tube; the voltage across B batteries or B eliminators, up to 300 volts.
- (6) to determine the condition of a tube, by use of the grid bias switch.
- (7) to measure any tube's electronic emission (tester cuts in at no load, hence plate current equals filament emission).
- (8) to regulate AC line, with the aid of a power rheostat, using a 27 tube as a guide, turning rheostat until filament voltage is 2.5 or 2.25 volts.
- (9) to test continuity of resistors, windings of chokes, transformers and circuits generally.
- (10) to find shorts in by-pass and other condensers, as well as in inductances, resistors and circuits generally.
- (11) to read grid bias voltages including those obtained through drops in resistors (bias read by noting plate current and voltage and consulting chart).
- (12) to determine the presence of distortion and overloading, by noting if milliammeter needle fluctuates.
- (13) to determine starting and stopping of oscillation, as milliammeter needle reads higher current for oscillation and lower for no oscillation.

## Fits Your Needs, As Well As Your Purse!

GUARANTY RADIO GOODS CO.,  
145 West 45th Street, New York City.

- Please send me at once, by parcel Post, on a five-day money-back guaranty, one complete Two-in-One (AC and DC) scientific trouble-shooting test set, consisting of one No. 215 and one No. 346, for which I will pay the postman \$13.50, plus a few cents extra for postage.
- If 0-500 v, high resistance voltmeter No. 347 is preferred, put cross in square and pay \$14.50, plus postage, instead of \$13.50, plus postage.
- One No. 215 and one No. 346, with two adapters for UV199 tubes \$14.50
- One No. 215 and one No. 347, with two adapters for UV199 tubes \$15.50
- One No. 215 alone, \$10.00.
- One No. 346 alone, \$4.50.
- One No. 347 alone, \$5.50.

NAME .....  
ADDRESS .....  
CITY ..... STATE.....

FIVE-DAY MONEY-BACK ABSOLUTE GUARANTY!

Try out the combination tester and high resistance voltmeter. If you are a service man, custom set builder, home constructor, experimenter, teacher or student, you run no risk. These instruments are guaranteed. Money back if you're not satisfied after a five-day test.

- High value and low price combine to give these instruments a field all to themselves, because they meet your needs fully in quality as well as in economy.
- HERE'S WHAT YOU GET FOR ONLY \$13.50:
- (1) One two-in-one 0 to 10 voltmeter for AC and DC. Same meter reads both. Scale specially legible at 1½ to 7½ volts. This meter reads the AC and DC filament voltages.
  - (2) One DOUBLE reading DC milliammeter, 0 to 20 and 0 to 100 milliamperes, with changeover switch. This reads plate current, which is always DC in all sets.
  - (3) One 0-300 volts high resistance voltmeter, No. 346, with tipped 30" cord to measure B voltages.
  - (4) One 5-prong plug with 30-inch cord for AC detector tubes, etc., and one 4-prong adapter for other tubes.
  - (5) One grid switch to change bias.
  - (6) One 5-prong socket.
  - (7) One 4-prong socket.
  - (8) Two blinding posts.
  - (9) One handsome noire metal case.
  - (10) One instruction sheet.
- [If 0-500 voltmeter No. 347 is desired instead of No. 346, price of combination is \$14.50.]
- No. 215 Universal AC-DC Tester Alone.....\$10.00  
No. 346 high resistance 0-300 voltmeter alone.....\$4.50  
No. 347 high resistance 0-500 voltmeter alone.....\$5.50

GUARANTY RADIO GOODS CO.  
145 West 45th Street  
New York City Just East of Broadway

*The Real*  
**WONDER**  
**HARMONIQUE**  
**222**  
*Screen Grid*  
*Marvelous Results!*

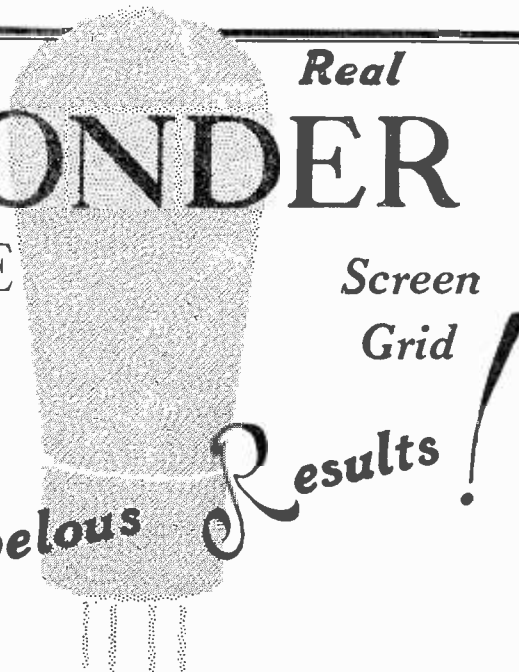

NOT since Dr. Lee De Forest invented the three-element tube has there been any tube development to compare with the four-element, Screen Grid Tube. But the tube must be expertly made—absolute precision. Then only do you realize the full gain. More distance, more volume, better tone. Instead of a gain of 8 or 10 per stage you can get from 50 to 240 with Screen Grid Tubes.

Harmonique 222 Screen Grid Tube, made with special attention to utmost precision and high amplification. Net price..... **\$3.50**

**MONEY-BACK AND REPLACEMENT GUARANTEE**

The strength of the guarantee measures the value of a tube. Only the best tubes can be given the best guarantee. All Harmonique Tubes are manufactured scientifically, carefully, expertly, and all are of the first order of merit. Hence all carry the same guarantee—**Money Back** if, after a five-day trial, you are not thoroughly delighted. **FREE Replacement** up to fifteen days after the date of receipt of tube, even if you "blow out" the tube.

**TUBE KITS FOR SPECIAL CIRCUITS**

If you have built or intend to build any of the popular kit circuits, get our specially boxed tube kit for that circuit, then forget possibility of tube troubles. Order the tubes by identifying them on the coupon below, and write the name of the circuit across the coupon.

**THE HARMONIQUE LINE OF TUBES**

Here is the full list of tubes to select from, always with the assurance you are getting an extraordinarily good tube, and at a very modest price, due to sale direct to you. The prices are net and include all charges. You don't have to pay postage.

201A	.....\$1.00	UX199	.....\$1.25	240	.....\$1.50
200A	.....2.00	UV199	.....1.25	222	.....3.50
112A	.....2.00	UV199 (standard socket)	.....1.25	280	.....3.50
171A	.....2.00	226AC	.....2.00	210	.....6.50
112	.....1.85	227AC	.....3.50	250	.....8.50
171	.....1.85				

NOTE: 112 and 171 specially designed for AC filament heating. The 240 has a mu (amplification factor) of 31. The 112, the 171, the 210 and the 250 sold in tested pairs for push-pull, if desired.

NO DEALERS SUPPLIED

**KELLY TUBE COMPANY**

8718 RIDGE BOULEVARD, BROOKLYN, N. Y.

—SEND NO MONEY!—

Kelly Tube Company, 8718 Ridge Boulevard, Brooklyn, N. Y.

Please mail me at once the following Harmonique tubes, guaranteed by you against damage in shipment, and on a 5-day money-back guarantee and 15-day FREE replacement guarantee, at advertised prices, which are net. You pay shipping costs.

.....Type..... Type..... Type.....  
.....Type..... Type..... Pair..... Push Pull

NAME..... ADDRESS.....  
CITY..... STATE.....

**Explanation of Push-Pull**

(Concluded from page 17)

plifier will not produce any distortion of appreciable magnitude.

Just as the change in the current drawn from the plate battery was zero for the signal, or first harmonic, so it is zero for all the odd harmonics. It is not zero for the even harmonics, but double the change for a single tube. Therefore if there were only odd harmonics it would not be necessary to by-pass the impedance of the plate battery or B battery eliminator. It is necessary to by-pass for the even harmonics. If the impedance of the plate voltage source is considerable there will be a voltage drop in it for even harmonics and that would unbalance the circuit for these harmonics. Hence without by-passing they will appear across the output terminals.

But the fact that there is no change in the plate current in the voltage supply at odd harmonics makes the circuit much less subject to motorboating and troubles of the same kind.

If there are any fluctuations in the voltage supply they will not affect the signal for the plate voltage of both tubes will change in the same direction at the same time. Hence even if the supply is not well filtered the ripple will not cause a hum in a well-balanced circuit. This applies also to changes in the battery C, and partially to the battery A.

If there is any unbalance in the circuit and if there is a considerable impedance in the voltage source that unbalance will be accentuated. The voltage drop in this impedance due to the difference current will be added to one side of the output and subtracted from the other side. To minimize this effect in a practical circuit, which invariably will have some unbalance, by-pass condensers should be used.

With this precaution taken a push-pull circuit will improve the signal very much even when there is some unbalance.

(See pages 18 and 19 for J. E. Anderson's article on his push-pull resistance coupled amplifier.)

**PARTS FOR**  
**ECONOMY THREE** **\$20.41**  
Exactly as Specified by  
**HERMAN BERNARD**

This astounding circuit can be built just as the designer built it at \$20.41. Here's what you get:

One Screen Grid Antenna Coil.....	\$1.75
One Screen Grid 3-Circuit Coil.....	3.00
Two .0005 variable condensers (\$1.50 ea.)	3.00
Six switches (20c ea.).....	.80
20-ohm fixed resistor.....	.25
10-ohm rheostat with knob.....	.85
2-ohm fixed resistor.....	.35
Three .00025 mfd. fixed (.45c ea.).....	1.35
One metallized resistor, 1 meg.....	.50
One metallized resistor, .5 meg.....	.60
One 5-lead cable.....	.50
One 7x18 drilled eng. front panel.....	2.00
One 7x14 drilled, eng. subpanel with sockets mounted.....	3.00
Two dials (65c ea.).....	1.30
Two tip jacks (15c ea.).....	.30
Four binding posts [Ant., Gnd., two C minus] (10c ea.).....	.40
One knob.....	.10
Two subpanel brackets 1-inch high (18c each).....	.36
	<b>\$20.41</b>

Harmonique tubes specified for Economy 3. Tubes not included in above list but cost you extra

222 (Screen Grid).....	\$3.50
240 (high mu).....	1.50
112A (power tube).....	2.00

**Voltage Supplies**

B eliminator delivering more than 135 v. to Economy 3 with Raytheon tube.....	\$16.00
A eliminator, dry plate type.....	22.00
C battery, 7½ v.....	.90
6-v. storage battery with dry charger and relay.....	14.00

**Custom Set Builders Supply Co.**  
168 Washington St., N. Y. City

# Real MUSICAL Instruments Are Made of Wood!

## THE SWEET MELLOWNESS OF WOOD GIVES REAL MUSIC!

THE finest reproduction is made possible by the long tone chamber horn loudspeaker, for then you hear the *true* sounds, without over-emphasis or under-emphasis, in other words, without distortion. Violins, pianos, flutes, cellos and the like are not made out of paper or cloth, but out of wood. Nature chose wood as the unsurpassed vehicle of sound. Man utilized the long tone chamber to make the sound supremacy of wood available for radio reproducers.

With fine quality moulded wood formed into a long tone chamber you hear the orchestral instruments stand out individually,—sounds from the boom of the bass drum, the zoom of the cello, to the sweet, high notes of piccolo and clarinet. And the human voice is natural, real. The hissing sounds of speech—high audio frequencies—come through as realistically as the guttural.

Use a long tone chamber horn, like the No. 595 illustrated at right, with a specially sensitive and faithful motor, (Cat. No. 112), shown at left and enjoy the best. Cat. No. 595, horn loudspeaker, tone travel 8 feet; over-all dimensions, 21 1/4" high, 18" wide, 13" or 15" deep. Nozzle takes standard size unit. Price \$10.80.

Felt-padded Baffle Board FREE with each order for a No. 595. The baffle is used as the inside shipping box. No need to remove the horn from the box. Use the outfit as you receive it, inside a cabinet, or in any other place you desire.



Horn Motor, Cat. No. 112. Price \$4.20.

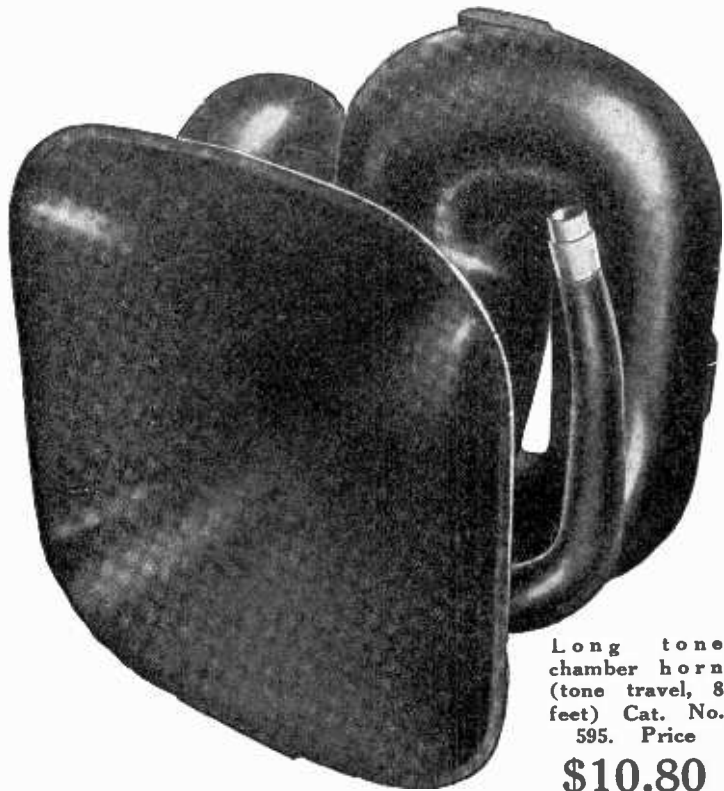

Long tone chamber horn (tone travel, 8 feet) Cat. No. 595. Price \$10.80

## Smaller Model Meets Space Economy Needs

WHERE space requirements limit you to a smaller size horn, use Cat. No. 570, illustrated below. The tone quality of this medium-sized model far surpasses that of the usual cones, but does not quite come up to that of the No. 595 on the extremely low register (40 cycles and less). However, it is a very satisfactory horn, as good as can be made for the smaller space.

Your mounting problems are solved completely with this model, as with the other, due to the inclusion of a FREE baffle board with each order.

No one need hesitate ordering the smaller model if space limitations compel such choice, for the result will be charming beyond expectations.

Cat. No. 570 horn loudspeaker, tone travel 6 feet; over-all dimensions 15" high, 12" wide, 12" deep. Nozzle takes standard size unit. Price \$7.80.

Felt padded baffle board FREE with each order for a No. 570.

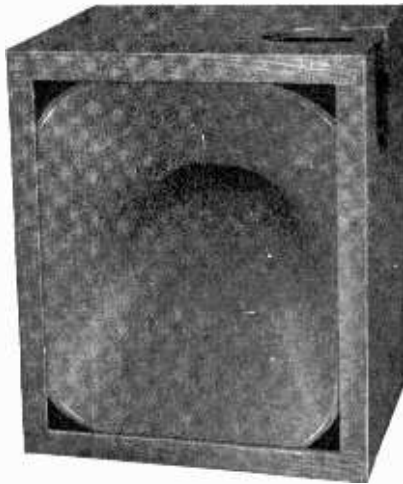

Baffle Board FREE with each horn order!

## FREE Baffle Board with Each Order

THE long tone chamber moulded wood horns are sold with an offer of a FREE baffle board that is felt-padded so that the horn is felt-suspended and doubly protected against possibility of rattles. This is the final point of protection and perfection.

### What DeForest Says:

"I do not consider any of the cones now on the market come anywhere near the perfect loudspeaker. Cones invariably favor some frequencies at the expense of others and most of the cones, while over-emphasizing the bass, put a mask of paper rustle over the higher frequencies. There are certain types of non-metallic horns now on the market which, with proper loudspeaker units, give far better reproduction than any 18-inch cone. I strongly advocate a radio set built into a large console cabinet with sufficient room to take in one of the larger exponential horns."

—Dr. Lee DeForest in "Radio News" for April, 1928.

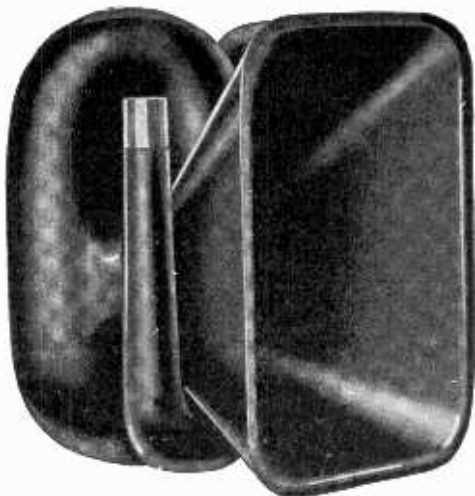

Medium sized tone chamber horn (tone travel, 6 feet) Cat. No. 570. Price \$7.80.

Why saddle a good set to a poor speaker?  
Travel 8 feet and get scnewhere! Travel 6 feet and outstrip the others, anyway!

### SEND NO MONEY!

ACOUSTICAL ENGINEERING ASSOCIATES, 143 West 45th Street, N. Y. City  
Please ship me at once the following (check off):

- One No. 595 at \$10.80 plus a little extra to defray shipping costs; also send FREE baffle board. 15" width will be sent unless 13" is specified by a cross in this square
- One No. 570 at \$7.80 plus a little extra to defray shipping costs; also send FREE baffle board.
- One No. 112 horn motor (universal nozzle) at \$4.20 plus a little extra for shipping.

Name .....

Address .....

City ..... State.....

5-Day Guarantee of Money Right Back if Not Delighted—  
No Stalling—No Questions!

# the WONDERS of Short Waves



**NATIONAL Velvet Vernier Dial, Type E**

For driving a condenser with shaft at right angles to the front panel. Has the same mechanism as the famous Type B Velvet Vernier Dial. Ratio 20-1. Beautiful hammered silver finish escutcheon plate. Easy to install. Price \$2.75. Type 28 Illuminator, 50c.

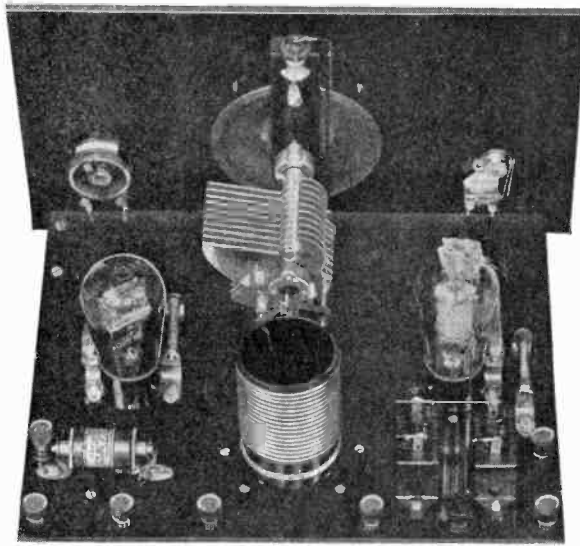

**NATIONAL Velvet Vernier Dial, Type N**

For Short Wave work. A solid German Silver Dial with the original Velvet Vernier mechanism and a real vernier for close reading to one-tenth division. Price \$6.50.

Do you know that over half a dozen of the leading broadcast stations in the country are **regularly** putting out their programs on the short waves?

Do you realize that these stations are the pioneers and that before long great numbers of broadcasting stations will be sending out **all** their programs on both long and short waves?

Do you know that you can listen to broadcasts of music and speech on the short waves all the way from England and Europe, in the day time?

Short-wave reception no longer means listening only to code signals. It means hearing regular broadcasts

from all over the world, with far less interference and static than you often get on a local station now.

Television Signals are being sent out now regularly on the short waves. Only a good short-wave receiver can pick up these signals and convert them back again into visible pictures.

National Co., Inc., has perfected new and better equipment for the easy construction of a simple, efficient, non-radiating short-wave receiver, including dials, condensers, R. F. Chokes, H. F. Impedances and interchangeable tuning transformers.

And for use in the audio of this or any other set, NATIONAL CO., INC., has built new and better audio transformers.

*And for use in the Audio of this or any set, here are new and better Transformers—*

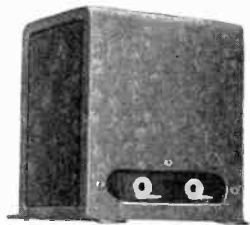

**NATIONAL AUDIO TRANSFORMERS**  
Type A100

The new NATIONAL Audio Transformer incorporates the latest advances in audio transformer design. It uses the new nickel-steel high permeability core and special split secondary winding. The result is a transformer of small size with unusually fine frequency characteristics. The transformer has a turn ratio of 4 to 1. Characteristics make it especially suitable for use in the audio stage preceding a push-pull output stage for television reception, as well as for the finest broadcast amplification. List price each, \$9.50.

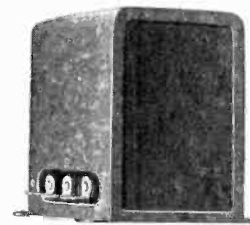

**NATIONAL PUSH-PULL TRANSFORMERS**  
Input, Type P-50. Output, Type P-10

These Transformers are built with a special nickel-steel alloy core and a novel method of coil winding, resulting in unusually fine frequency characteristics without being unduly cumbersome. A test made in the laboratory of the largest radio set manufacturer in the country showed a curve of the frequency characteristics of these Transformers to be essentially a straight horizontal line from 30 to 5000 cycles, as required for audio amplifiers for experimental television reception and for the highest quality of broadcast reception. List price each, \$9.50.

# NATIONAL

**RADIO PRODUCTS**

*Write us for Special Bulletin SW-128-RW*



**NATIONAL CO., INC. W. A. Ready, Pres. SHERMAN ABBOT & JACKSON STS., MALDEN, MASS.**